

A LECTURE NOTE
ON
WATER SUPPLY & WASTE
WATER ENGINEERING
(TH-4)



By :- P Sankar Rao
Guest Faculty in Civil Engineering

GOVERNMENT POLYTECHNIC,
MALKANGIRI
At- Pradhaniguda

INTRODUCTION

Absolutely pure water is never found in nature but the water found in nature contains number of impurities in varying amounts. The rainwater which is originally pure, also absorbs various gases, dust and other impurities while falling. This water when moves on the ground further carries silt, organic and inorganic impurities.

Wholesome water is defined as the water which containing the minerals in small quantities at requisite levels and free from harmful impurities. The water that is fit for drinking safe and agreeable is called **potable water**.

The following are the requirements of wholesome water.

- It should be free from bacteria
- It should be colourless and sparkling
- It should be tasty, odour free and cool
- It should be free from objectionable matter
- It should not corrode pipes
- It should have dissolved oxygen and free from carbonic acid so that it may remain fresh

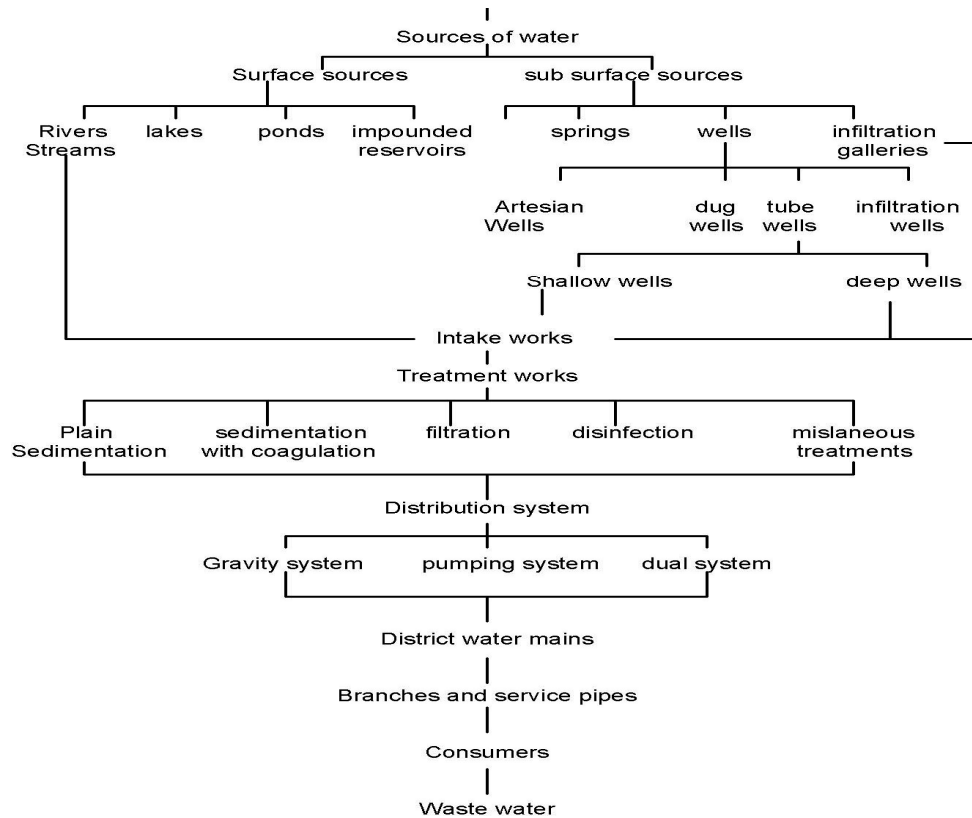

SOURCES OF WATER

All the sources of water can be broadly divided into

1. **Surfaces sources**
2. **Sub surface sources**

The **surface sources** further divided into

- i. **Streams**
- ii. **Rivers**
- iii. **Ponds**
- iv. **Lakes**
- v. **Impounding reservoirs etc.**

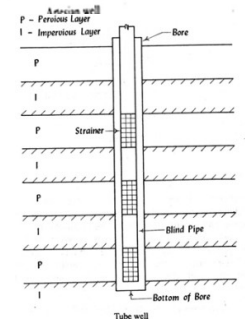
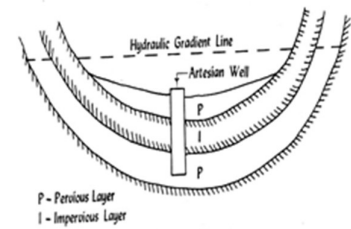
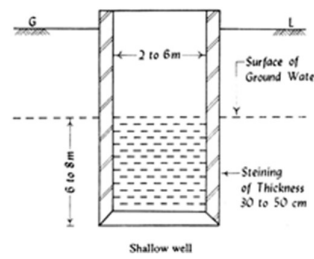

The **subsurface sources** further divided into

- (i) **Infiltration galleries**
- (ii) **Infiltration wells**
- (iii) **Springs etc**

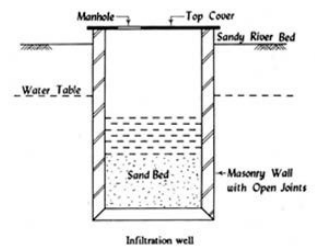
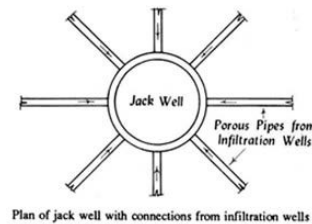
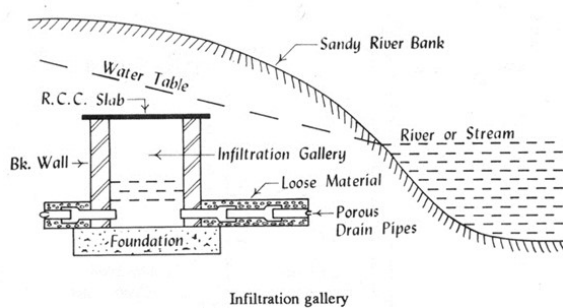

Types of Intake structures

Depending upon the source of water the intake works are classified as following

- **Lake Intake**
- **Reservoir Intake**
- **River Intake**
- **Canal Intake**

WATER DEMANDS

- While designing the water supply scheme for a town or city, it is necessary to determine the total quantity of a water required for various purposes by the city.
- As a matter of fact the first duty of the engineer is to determine the water demand of the town and then to find suitable water sources from where the demand can be met.
- But as there are so many factors involved in demand of water, it is not possible to accurately determine the actual demand.
- Certain empirical formulae and thumb rules are employed in determining the water demand, which is very near to the actual demand.

TYPES OF WATER DEMANDS

- **Domestic water demand**
- **Industrial demand**
- **commercial demand**
- **Demand for public use**
- **Fire demand**
- **Loses and wastes**

DOMESTIC WATER DEMAND

As per IS:1172-1963, under normal conditions, the domestic consumption of water in India is about 135litres/day/capita. But in developed countries this figure may be 350 litres/day/capita because of use of air coolers, air conditioners, maintenance of lawns, automatic household appliances.

Bathing	:55 litres
Toilet flushing	:30 litres
Washing of clothes	:20 litres
Washing the house	:10 litres
Washing utensils	:10 litres
Cooking	:5 litres
Drinking	:5 litres.

FIRE DEMAND

During the fire breakdown large quantity of water is required for throwing it over the fire to extinguish it, therefore provision is made in the water work to supply sufficient quantity of water or keep as reserve in the water mains for this purpose.

In the cities fire hydrants are provided on the water mains at 100 to 150 m apart for fire demand. The quantity of water required for fire fighting is generally calculated by using different empirical formulae.

For Indian conditions Kuichings formula gives satisfactory results.

$$Q = 3182 \sqrt{P}$$

Where 'Q' is quantity of water required in litres/min

'P' is population of town or city in thousands

PER CAPITA DEMAND

If 'Q' is the total quantity of water required by various purposes by a town per year and 'P' is population of town, then per capita demand will be

Per capita demand = $[Q / (P \times 365)]$ litres/day

Per capita demand of the town depends on various factors like standard of living and type of commercial places in a town etc.

Domestic purpose	: 135 litres/day
Industrial use	: 40 litres/day
Public use	: 25 litres/day
Fire Demand	: 15 litres/day
Losses, Wastage and thefts	: 55 litres/day
Total	: 270 litres/capita/day.

FACTORS AFFECTING PER CAPITA DEMAND

The following are the main factors affecting for capita demand of the city or town.

- Climatic conditions
- Size of community
- Living standard of the people
- Industrial and commercial activities
- Pressure in the distribution system
- System of sanitation
- Cost of water

POPULATION FORECASTING METHOD

The following are the standard methods by which the forecasting population is done.

- Arithmetical increase method
- Geometrical increase method
- Incremental increase method
- Simple graph method
- Decrease rate of growth method
- Comparative graph method
- The master plan method

ARITHMETICAL INCREASE METHOD

This method is based on the assumption that the population is increasing at a constant rate. The rate of change of population with time is constant. The population after 'n' decades can be determined by the formula.

$$P_n = P + n.c \text{ where}$$

P → population at present

n → No. of decades

c → Constant determined by the average
of increase of 'n' decades

YEAR	POPULATION	INCREASE IN POPULATION
1940	8000	---
1950	12000	4000
1960	17000	5000
1970	22500	5500
	TOTAL	14500
	AVERAGE	4833

Solution:

YEAR	POPULATION
1980	$22500 + 1 \times 4833 = 27333$
1990	$22500 + 2 \times 4833 = 32166$
2000	$22500 + 3 \times 4833 = 36999$

GEOMETRICAL INCREASE METHOD

This method is based on the assumption that the percentage increase in population from decade to decade remains constant. In this method the average percentage of growth of last few decades is determined, the population forecasting is done on the basis that percentage increase per decade will be the same.

The population at the end of 'n' decades is calculated by

$$P_n = P \left(1 + \frac{IG}{100} \right)^n$$

where

- P → population at present
 C → average percentage of growth of 'n' decades

Year	Population	Increase in population	Percentage increase in population
1940	8000	---	---
1950	12000	4000	$\frac{4000}{8000} \times 100 = 50\%$
1960	17000	5000	$\frac{5000}{12000} \times 100 = 41.7\%$
1970	22500	5500	$\frac{5500}{17000} \times 100 = 32.4\%$
	TOTAL	14500	124.1%
	AVERAGE	4833	41.37%

The population at the end of various decades shall be as follows:

YEAR	EXPECTED POPULATION
1980	$22500 + 41.37 / 100 \times 22500 = 31808$
1990	$31800 + 41.37 / 100 \times 31800 = 49935$
2000	$49935 + 41.37 / 100 \times 49395 = 68524$

INCREMENTAL INCREASE METHOD

This method is improvement over the above two methods. The average increase in the population is determined by the arithmetical method and to this is added the average of the net incremental increase once for each future decade.

The population at the end of the various decades shall be as follows

Year	Population	Increase in population	Incremental increase
1940	8000	---	---
1950	12000	4000	---
1960	17000	5000	+ 1000
1970	22500	5500	+ 1500
	TOTAL	14500	+ 2500
	AVERAGE	4833	1,250

YEAR	EXPECTED POPULATION
1980	$22500 + (4833 + 1250) \times 1 = 28583$
1990	$22500 + (4833 + 1250) \times 2 = 34666$
2000	$22500 + (4833 + 1250) \times 3 = 40749$

QUALITY OF WATER

Wholesome water – not chemically pure .but does not contain anything harmful to Human body

Impurities in water

- ❖ Suspended impurities
- ❖ Colloidal impurities
- ❖ Dissolved impurities

In suspended impurities

- Silt ,clay
- algae, Fungi
- organic & inorganic matter
- turbidity

In Colloidal impurities

- Neither in suspension nor in solution
- They are electrically charged
- micron

In Dissolved impurities

➤ Salts of calcium magnesium & sodium

➤ Ppm

DRINKING WATER STANDARDS

S.No.	CHARACTERISTICS	NORMALLY ACCEPTABLE VALUE	MAX. PERMISSIBLE LIMIT
1.	Temperature	10°C – 15°C	-
2.	Turbidity (N.T.U)	2.5	10
3.	Colour (platinum cobalt scale)	5.0	25
4.	Taste and odour	Unobjectionable	
5.	PH	7.0-8.5	6.5-9.2
6.	Total dissolved solids(mg/litre)	500	1500
7.	Total hardness mg/l (as CaCO_3)	200	600
8.	Chlorides (as Cl) mg/l	200	1000
9.	Sulphates (as SO_4) mg/l	200	400
10.	Nitrates (as NO_3) mg/l	45	45
11.	Fluorides (as F) mg/l	1.0	1.5
12.	Calcium (as Ca) mg/l	75	200
13.	Magnesium (as mg) mg/l	30-120	150
14.	Iron (as Fe) mg/l	0.1	1.0
15.	Manganese (As Mn) mg/l	0.05	0.5
16.	Phenolic compounds (as phenol) mg/l	0.001	0.002
17.	Arsenic (as mg) mg/l	0.05	0.05
18.	Chromium (as Cr^{+6}) mg/l	0.05	0.05
19.	Cyanamides (as CN) mg/l	0.05	0.05
20.	Coliform count per 100ml of water sample	Zero	-

PHYSICAL TEST

Colour

Taste and odour

Temperature

Turbidity

CHEMICAL TEST

Total solids

Hardness

Chlorides

Dissolved gases

PH value or hydrogen- Ion concentration

Nitrogen and its compounds

Metals and other chemical substances

BACTERIOLOGICAL TESTS

M.P.N.Test

E. Coli Test

PHYSICAL TEST

TURBIDITY

Turbidity caused due to presence of suspended and colloidal matter in the water. The character and amount of turbidity depends upon the type of soil over which the water has moved ground waters are less turbid than the surface water. Turbidity is a measure of resistance of water to the passage of light through it.

Turbidity is expressed as NTU (Nephelometric Turbidity Units) or PPM (parts per million) or Milligrams per litre (mg/l). Turbidity is measured by

1) Turbidity rod or Tape 2) Jacksons Turbidimeter 3) Bali's Turbidimeter

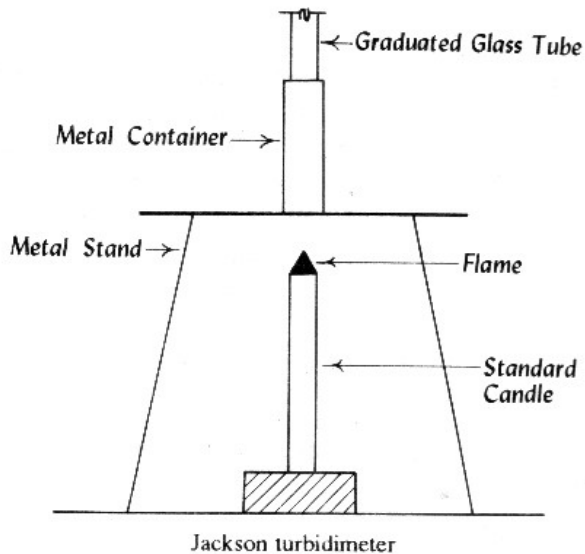

Drinking water should not have turbidity more than 10 N.T.U. This test is useful in determining the detention time in settling for raw water and to dosage of coagulants required to remove turbidity

COLOUR AND TEMPERATURE

- Colour in water is usually due to organic matter in colloidal condition but some times it is also due to mineral and dissolved organic impurities.
- The colour produced by one milligram of platinum in a litre of water has been fixed as the unit of colour.
- The permissible colour for domestic water is 20ppm on platinum cobalt scale.
- Temperature of water is measured by means of ordinary thermometers.
- The most desirable temperature for public supply between 4.4°C to 10°C. The temperature above 35°C are unfit for public supply, because it is not palatable.

TASTE AND ODOUR

- Taste and odour in water may be due to presence of dead or live micro-organisms, dissolved gases such as hydrogen sulphide, methane, carbon dioxide or oxygen combined with organic matter, mineral substances such as sodium chloride, iron compounds and carbonates and sulphates of other substances.
- The water having bad smell and odour is objectionable

CHEMICAL TEST

TOTAL SOLIDS AND SUSPENDED SOLIDS

PH VALUE OF WATER

- PH value denotes the concentration of hydrogen ions in the water and it is a measure of acidity or alkalinity of a substance.
- Depending upon the nature of dissolved salts and minerals, the PH value ranges from 0 to 14. For pure water, PH value is 7 and 0 to 7 acidic and 7 to 14 alkaline range.
- For public water supply PH value may be 6.5 to 8.5.
- determined by PH papers or by using PH meter.

$$PH = -\log_{10}[H^+] \text{ or } 14 - \log_{10}[H^+]$$

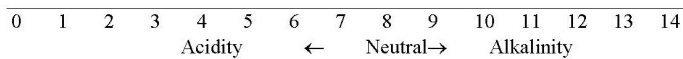

HARDNESS OF WATER

- It is a property of water, which prevents the lathering of the soap. Hardness is of two types.
- **Temporary hardness:** It is caused due to the presence of carbonates and sulphates of calcium and magnesium. It is removed by boiling.
- **Permanent hardness:** It is caused due to the presence of chlorides and nitrates of calcium and magnesium. It is removed by zeolite method.
- Hardness is usually expressed in gm/litre or p.p.m. of calcium carbonate in water.

CHLORIDE CONTENT

- The natural waters near the mines and sea dissolve sodium chloride and also presence of chlorides may be due to mixing of saline water and sewage in the water.
- Excess of chlorides is dangerous and unfit for use.
- The chlorides can be reduced by diluting the water.
- Chlorides above 250p.p.m. are not permissible in water.

BACTERIOLOGICAL TESTS

- The examination of water for the presence of bacteria is important for the water supply engineer from the viewpoint of public health.
- The bacteria may be harmless to mankind or harmful to mankind.
- The former category is known as non-pathogenic bacteria and the later category is known as pathogenic bacteria.

- Many of the bacteria found in water are derived from air, soil and vegetation.
- Some of these are able to multiply and continue their existence while the remaining die out in due course of time.
- The selective medium that promote the growth of particular bacteria and inbuilt the growth of other organisms is used in the lab to detect the presence of the required bacteria, usually coliform bacteria.
- For bacteriological analysis the following tests are done.

PLANT COUNT TEST

In this method total number of bacteria presents in a millitre of water is counted. 1 ml of sample water is diluted in 99ml of sterilized water and 1ml of dilute water is mixed with 10ml of agar of gelatine. This mixture is then kept in incubator at 37°C for 24 hours or 20°C for 48 hours. After the sample will be taken out from the incubator and colonies of bacteria are counted by means of microscope. Drinking water should not have more than 10 coliforms/100ml.

M.P.N. TEST (MOST PROBABLE NUMBER)

The detection of bacteria by mixing different dilutions of a sample of water with fructose broth and keeping it in the incubator at 37°C for 48hours. The presence of acid or carbon-dioxide gas in the test tube will indicate the presence of B-coli. After this the standard statistical tables (Maccardy's) are referred and the "MOST PROBABLE NUMBER" (MPN) of B-coli per 100ml of water are determined. For drinking water, the M.P.N. should not be more than 2.

WATER BORNE DISEASES

World health organization has observes that 80% of communicable diseases that are transmitted through water. The diseases like cholera, gastroenteritis, typhoid, amoebia, diarrhoea, polio, hepatitis (Jaundice), Leptospirosis, Dracontiasis are caused by bacteria.

Excess of fluorides present in water [above 1.5 mg/litre] cause diseases like dental flurosis, sketetal flurosis. This is a permanent irresible disease that weakens the bone structure. The patient becomes immobile and bedridden.

TREATMENT OF WATER

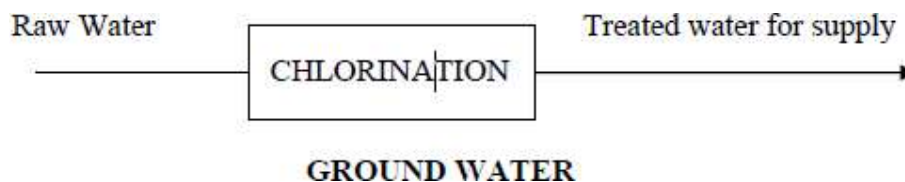

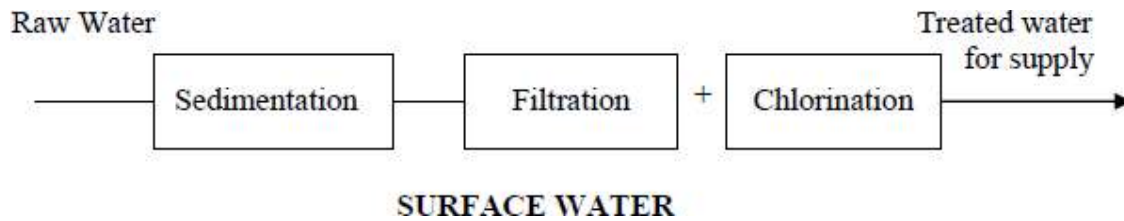

One complete water treatment plant requires the following process starting from the source of water upto the distribution zone in order of sequence.

Sl.No.	Name of the unit	Purpose
1.	Intake work including pumping plant	Raw water from the source for treatment
2.	Plain sedimentation	To remove suspended impurities such as silt, clay, sand etc.
3.	Sedimentation with coagulation	To remove the suspended matter
4.	Filtration	To remove microorgans and colloidal matter
5.	Water softening plant	To remove hardness of water
6.	Miscellaneous treatment plants	To remove dissolved gases, tastes and odours.
7.	Disinfection	To remove pathogenic bacteria
8.	Clear water reservoir	To store the treated water
9.	Pumps for pumping the water in service reservoirs	If town or city is situated at higher elevation then pumping is required.
10.	Elevated or underground service reservoir	For distribution of treated water.

In treatment of water the process are

- ❖ Primary Treatment
- ❖ Secondary Treatment
- ❖ Tertiary Treatment

INTAKE OF WATER

SCREENING

Screens are fixed in the intake works or at the entrance of treatment plant. the filtration of coarser floating and suspended materials. So, the larger materials like we may have papers coming in the water wood, leaves, aquatic plants then polyethene, these kind of things may come floating with the water and then they needs to be filtered out so that it does not enter into the our main basin or through equipment and pump and do not spoil them.



Types of screening are

Rotatory & Bar screening method

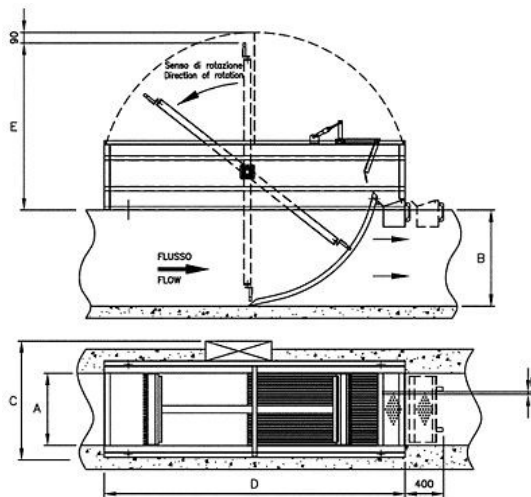

PRIMARY TREATMENT

AERATION

Aeration is usually **effective against several pollutants** are discussed **the dissolved gases** like random **carbon dioxide** , some **taste and odour** producing compounds like methane **hydrogen sulphide**, the **volatile organic compounds** like MTB or industrial solvents, it can also **raise the pH of water** and it can be used for precipitation and **removal of iron and manganese** aeration.

Aeration is usually **not effective against other heavy metals** it does not affect them much it is not effective **against pathogens** okay. So, the **disease-causing organisms** like **bacteria and virus** rather they may get more oxygen and they may get like they may proliferate more or so, **rapid growth with Aeration**, and it is not effective **against the turbidity and other suspended materials**.

SEDIMENTATION

In sedimentation there are Sedimentation aided with coagulation.

PLAIN SEDIMENTATION

By plain sedimentation the following are the advantages.

- 1. Plain sedimentation lightens the load on the subsequent process.
- 2. The operation of subsequent purification process can be controlled in better way.
- 3. The cost of cleaning the chemical coagulation basins is reduced.
- 4. No chemical is lost with sludge discharged from the plain settling basin.
- 5. Less quantity of chemicals are required in the subsequent treatment processes.

The design aspects of sedimentary tanks are

- 1. Velocity of flow
- 2. Capacity of tank
- 3. Inlet and outlet arrangements
- 4. Shapes of tanks
- 5. Miscellaneous considerations.

SHAPES OF TANKS

Following are the three shapes of settling tank

- ❑ Rectangular tanks with horizontal flow
- ❑ Circular tanks with radial or spiral flow
- ❑ Hopper bottom tanks with vertical flow

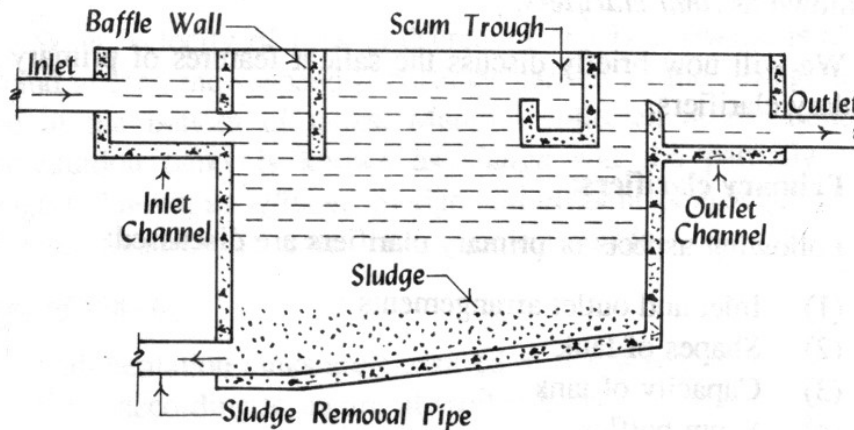

Rectangular settling tank

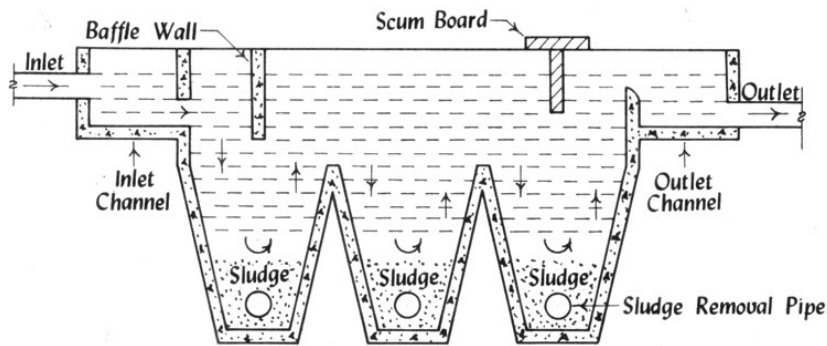

Hopper bottom settling tank

SEDIMENTATION AIDED WITH COAGULATION

When water contains fine clay and colloidal impurities which are electrically charged are continually in motion and never settle down due to gravitational force. Certain chemicals are added to the water so as to remove such impurities which are not removed by plain sedimentation. The chemical form insoluble, gelatinous, flocculent precipitate absorbs and entangle very fine suspended matter and colloidal impurities during its formation and descent through water. These coagulants further have an advantage of removing colour, odour and taste from the water. Turbidity of water reduced upto 5-10 ppm and bacteria removes upto 65%.

Sl.No.	Coagulant	PH Range	Dosage mg/l
1.	Aluminium sulphate $Al_2(SO_4)_3, 18 H_2O$	5.5 – 8.0	5 – 85
2.	Sodium Aluminate, $Na_2Al_2O_4$	5.5 – 8.0	3.4 – 34
3.	Ferric Chloride ($FeCl_3$)	5.5 – 11.0	8.5 – 51
4.	Ferric Sulphate $Fe_2(SO_4)_3$	5.5 – 11.0	8.5 – 51
5.	Ferric Sulphate $FeSO_4 \cdot 7H_2O$	5.5 – 11.0	8.5 – 51

Table 5.1

FILTRATION

The process of passing the water through beds of sand or other granular materials is known as **filtration**. Filters are used for removing bacteria, colour, taste, odours and producing clear and sparkling water.

By sand filtration 95 to 98% suspended impurities are removed.

Filtration is carried out in three types of filters

- Slow sand filter
 - Rapid sand filter
 - Trickling Filter
 - Pressure filter
- } Gravity filters

SLOW SAND FILTER

Slow sand filters are best suited for the filtration of water for small towns. The sand used for the filtration is specified by the effective size and uniformity coefficient .

Slow sand filter is made up of a top layer of fine sand of effective size 0.2. to 0.3mm and uniformity coefficient 2 to 3 . The thickness of the layer may be 75 to 90 cm. Below the fine sand layer, a layer of coarse sand of such size whose voids do not permit the fine sand to pass through it. The thickness of this layer may be 30cm. The lowermost layer is a graded gravel of size 2 to 45mm and thickness is about 20 to 30cm. The gravel is laid in layers such that the smallest sizes are at the top.

The gravel layer retains the coarse sand layer and is laid over the network of open jointed clay pipe or concrete pipes called under drainage. Water collected by the under drainage is passed into the out chamber

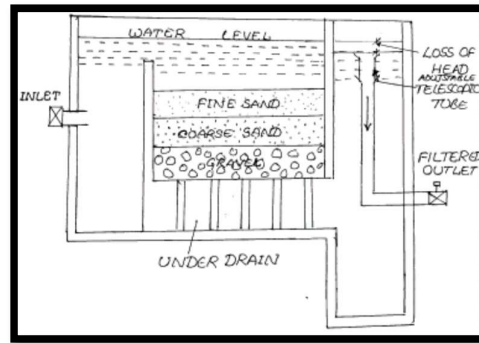
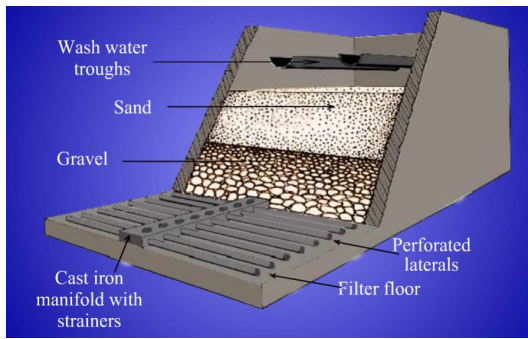

TRICKLING FILTER

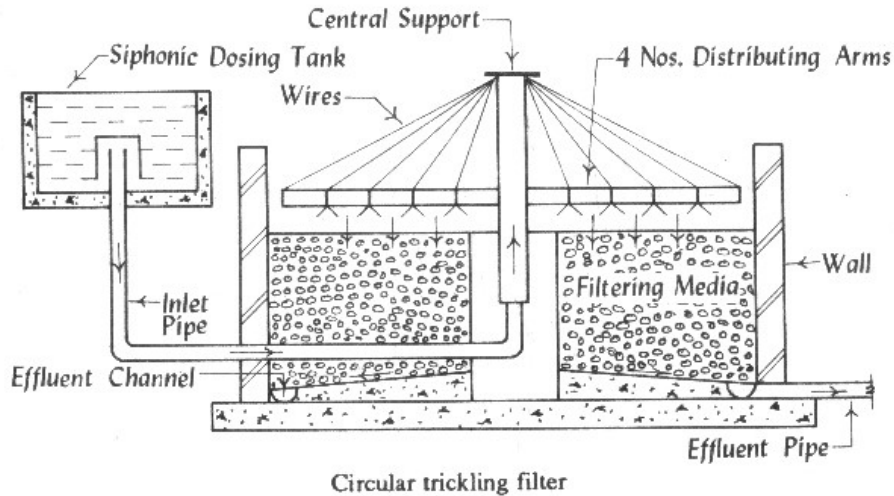

Filter is open to atmosphere, air flows naturally through media. Treated water leaves bottom of tank, flows into secondary clarifier. Bacterial cells settle, removed from clarifier as sludge. Some water is recycled to the filter, to maintain moist conditions.



PRESSURE FILTER

Pressure filter is type of rapid sand filter in a closed water tight cylinder through which the water passes through the sand bed under pressure. All the operations of the filter is similar to rapid gravity filter, expect that the coagulated water is directly applied to the filter without mixing and flocculation. These filters are used for industrial plants but these are not economical on large scale. Pressure filters may be vertical pressure filter and horizontal pressure filter.

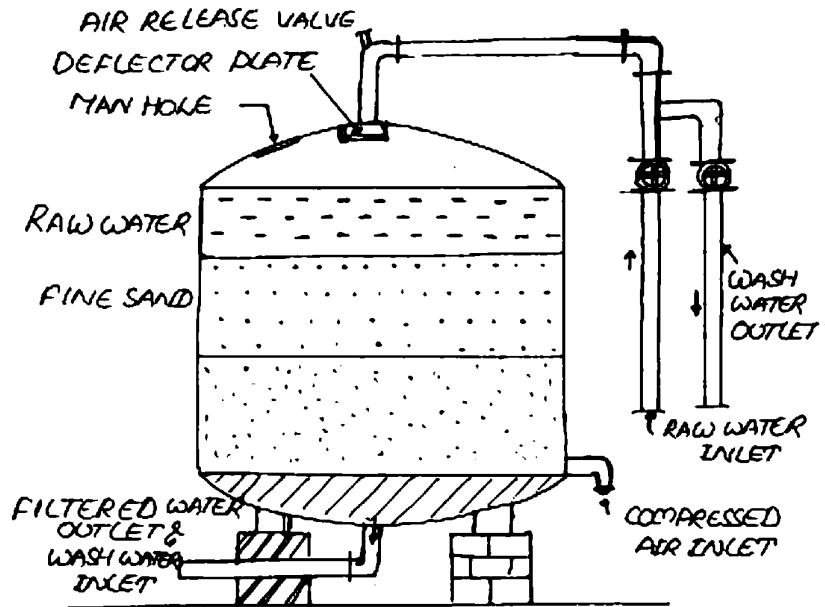

DISINFECTION

The filtered water may normally contain some harmful disease producing bacteria in it. These bacteria must be killed in order to make the water safe for drinking. The process of killing these bacteria is known as Disinfection or Sterilization.

1. **Boiling:** The bacteria present in water can be destroyed by boiling it for a long time. However it is not practically possible to boil huge amounts of water. Moreover it cannot take care of future possible contaminations.
2. **Treatment with Excess Lime:** Lime is used in water treatment plant for softening. But if excess lime is added to the water, it can in addition, kill the bacteria also. Lime when added raises the pH value of water making it extremely alkaline. This extreme alkalinity has been found detrimental to the survival of bacteria. This method needs the removal of excess lime from the water before it can be supplied to the general public. Treatment like recarbonation for lime removal should be used after disinfection.
3. **Treatment with Ozone:** Ozone readily breaks down into normal oxygen, and releases nascent oxygen. The nascent oxygen is a powerful oxidising agent and removes the organic matter as well as the bacteria from the water.
4. **Chlorination:** The germicidal action of chlorine, according to which the chlorine enters the cell walls of bacteria and kill the enzymes which are essential for the metabolic processes of living organisms.

PHYSICAL METHODS

BOILING : Boil the water for 15 to 20 minutes and kills the disease causing bacteria. This process is applicable for individual homes.

ULTRA-VIOLET RAYS: Water is allowed to pass about 10cm thickness by ultraviolet rays. This process is very costly and not used at water works. Suitable for institutions.

ULTRASONIC RAYS: Suitable for institutions.

CHEMICAL METHODS

CHLORINATION :

Using chlorine gas or chlorine compounds.

BROMINE AND IODINE :

It is expensive and leaves taste and odour

POTASSIUMPERMANGANATE:

This method is used for disinfection of dug well water, pond water or private source of water.

OZONE :

Very expensive process, leaves no taste, odour or residual.

EXCESS LIME TREATMENT

LAYOUTS OF DISTRIBUTION NETWORK

The distribution pipes are generally laid below the road pavements, and as such their layouts generally follow the layouts of roads. There are, in general, four different types of pipe networks; any one of which either singly or in combinations, can be used for a particular place. They are:

Dead End System

Grid Iron System

Ring System

Radial System

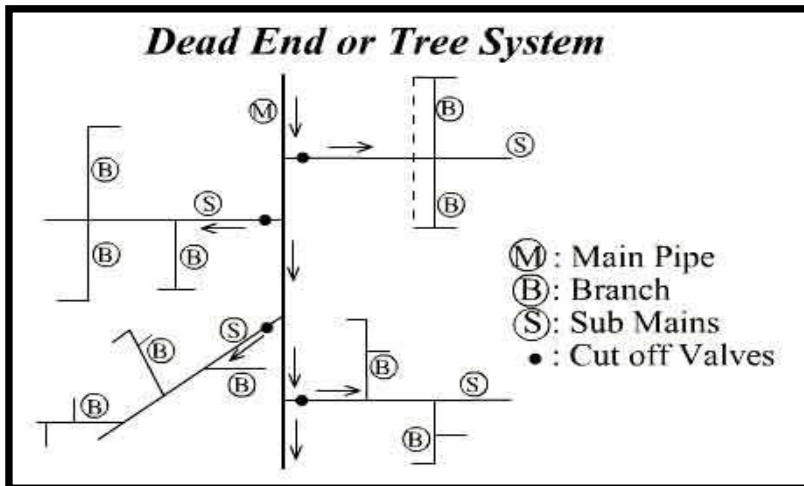

- ❖ It is suitable for old towns and cities having no definite pattern of roads.
- ❖ Relatively cheap.
- ❖ Determination of discharges and pressure easier due to less number of valves.
- ❖ Due to many dead ends, stagnation of water occurs in pipes.

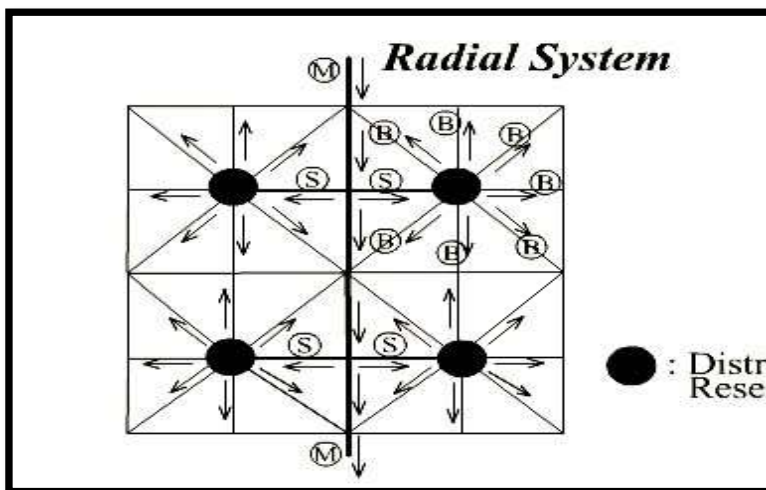

- ❖ The area is divided into different zones.
- ❖ The water is pumped into the distribution reservoir kept in the middle of each zone.
- ❖ The supply pipes are laid radially ending towards the periphery.
- ❖ It gives quick service.
- ❖ Calculation of pipe sizes is easy.

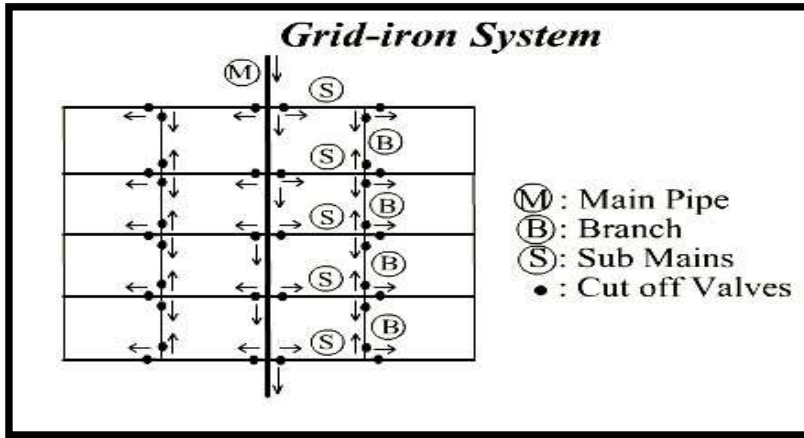

- ❖ It is suitable for cities with rectangular layout, where the water mains and branches are laid in rectangles.
- ❖ Water is kept in good circulation due to the absence of dead ends.
- ❖ In the cases of a breakdown in some section, water is available from some other direction.
- ❖ Exact calculation of sizes of pipes is not possible due to provision of valves on all branches.

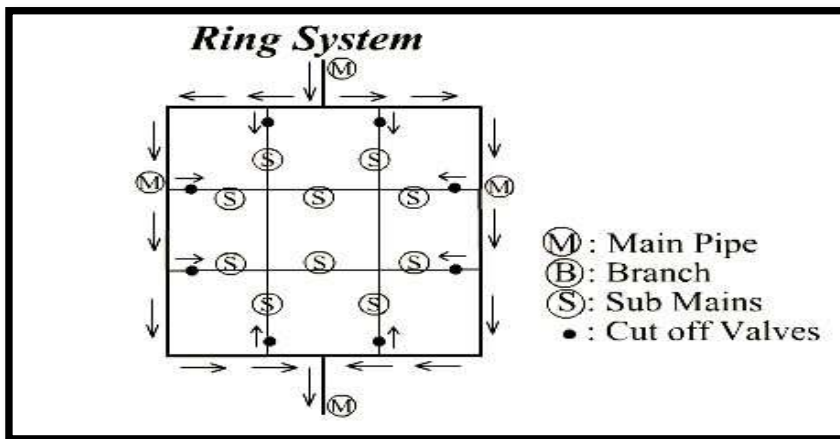

- ❖ The supply main is laid all along the peripheral roads and sub mains branch out from the mains.
- ❖ This system also follows the grid iron system with the flow pattern similar in character to that of dead end system.
- ❖ So, determination of the size of pipes is easy.
- ❖ Water can be supplied to any point from at least two directions.

SYSTEM OF DISTRIBUTION

Sources	Open Well, Tube Well, Hand pump, Pond, Dam Site, External Pipe Supply, Rain Water Harvesting System/Tank
Village/town level Treatment	Reverse Osmosis System (RO), Chlorination, Sedimentation, Sand Filter, etc.
Storage	Elevated Surface Reservoirs (ESR), Ground Service Reservoirs (GSR), Sump
Distribution	Main Line, Sub-Main Line, Branch Pipe Line, Household Level Tape, Stand Post, Washing Unit.

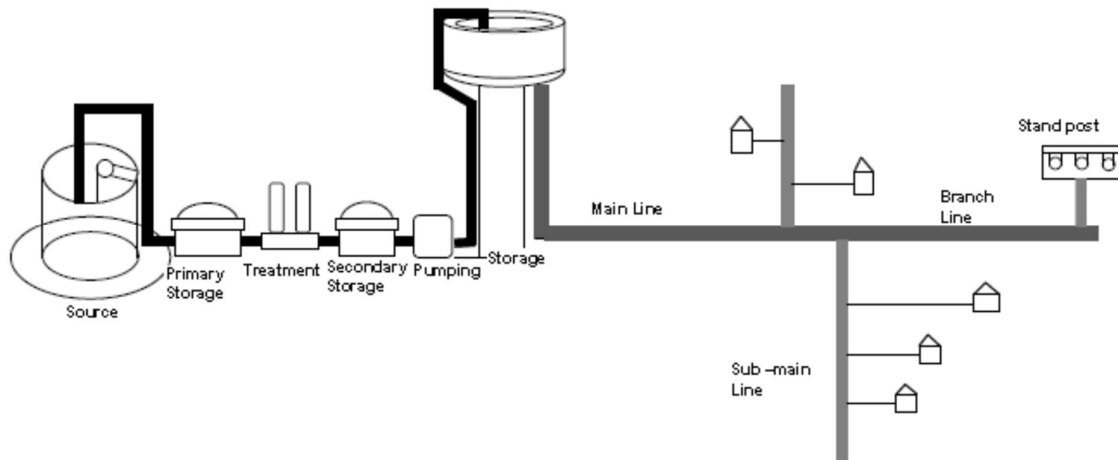

STORAGE FACILITIES

Elevated Surface Reservoir (ESR) or elevated storage tank: ESR is constructed, where water is to be supplied at elevated height (less than the level of ESR) or where the distance is large and topography is undulating. Generally, ESR is at height more than 15 m. Water can be distributed directly from this storage tank by gravity or pump.

Ground Service Reservoir (GSR): GSR is ground level or plinth level storage tank. The plinth level is generally not more than 3 m.

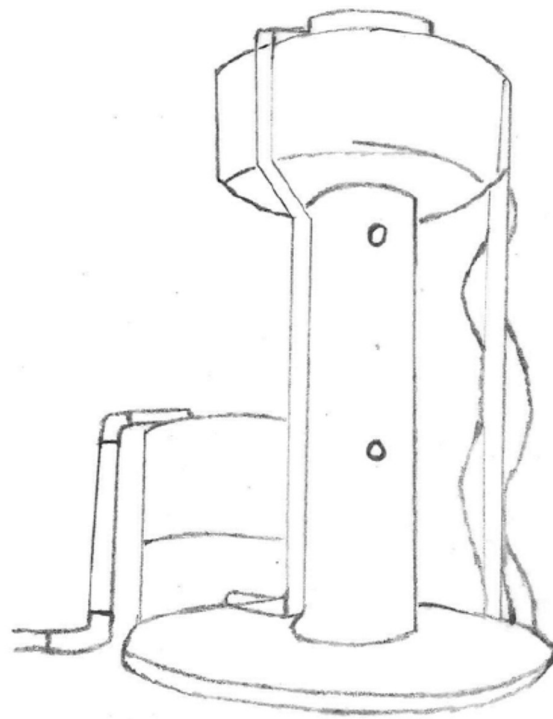

GSR & ESR

Sump: Sump is used as additional storage at village/town level or cluster level. It is not used for direct distribution of water. Rather, it is used as intermediate or

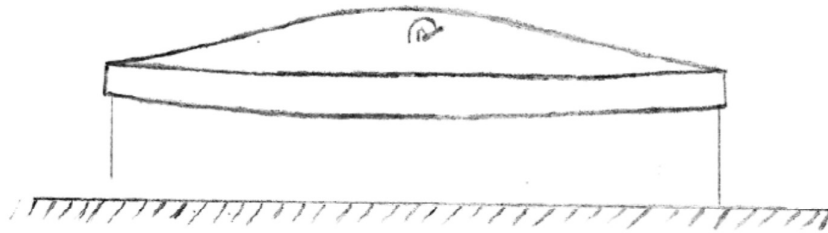

Sump

contingency storage, to store water before it is pumped to ESR/GSR. The underground storage tank in circular shape with dome line covering is called sump. Generally, the capacity of sump is more (one and half to two times) than ESR or GSR or two to five days water requirement, so that if the supply is disturbed for that time, the water is available for the people.

The water may be supplied to the consumers by either of the two systems.

➤ **CONTINUOUS SYSTEM**

➤ **INTERMITTENT SYSTEM**

a. Continuous

In this system, there is continuous water supply (for 24 hours). This is possible where adequate quantity of water is available. The major advantage of such system is that due to continuous water supply, water remains fresh and rusting of pipes will be low. However, losses of water will be more in case of any leakage.

b. Intermittent

In such system, supply of water is either done in whole village/town for fixed hours or supply of water is divided into zones and each zone is supplied with water for fixed hours in a day or as per specified day. Such system is followed when there is low water availability, however, in certain cases, wastage of water is more due to tendency of community for storing higher amount of water than required. In such system, pipelines are likely to rust faster due to wetting and drying. However, maintenance can be easily done during no-supply hours.

CONTINUOUS SYSTEM

This is the best system and water is supplied for all 24 hours. This system is possible when there is adequate quantity of water for supply. In this system sample of water is always available for fire fighting and due to continuous circulation water always remains fresh. In this system less diameter of pipes are required and rusting of pipes will be less. Losses will be more if there are leakages in the system.

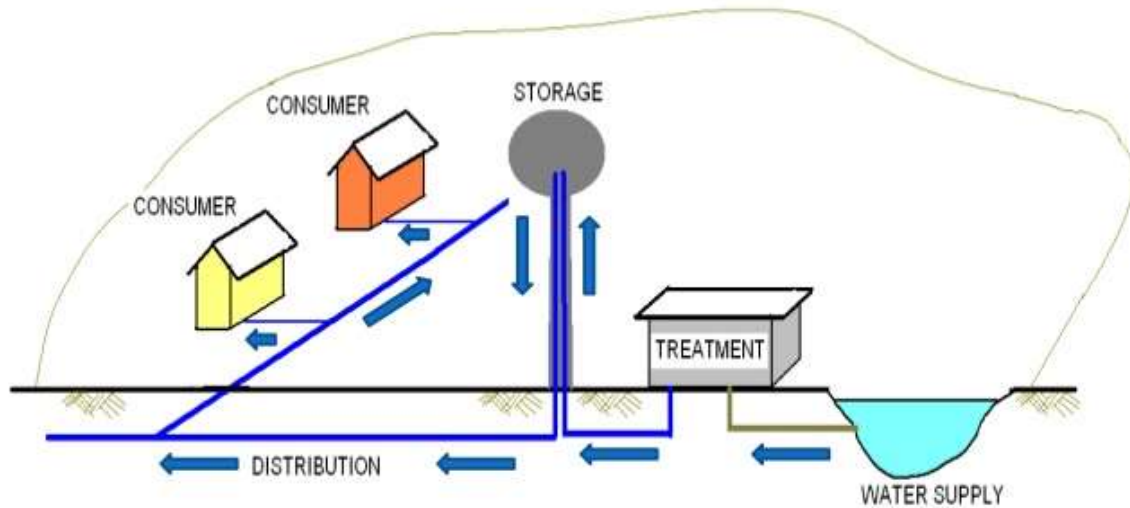

INTERMITTENT SYSTEM

If plenty of water is not available, the supply of water is divided into zones and each zone is supplied with water for fixed hours in a day or on alternate days. As the water is supplied after intervals, it is called intermittent system.

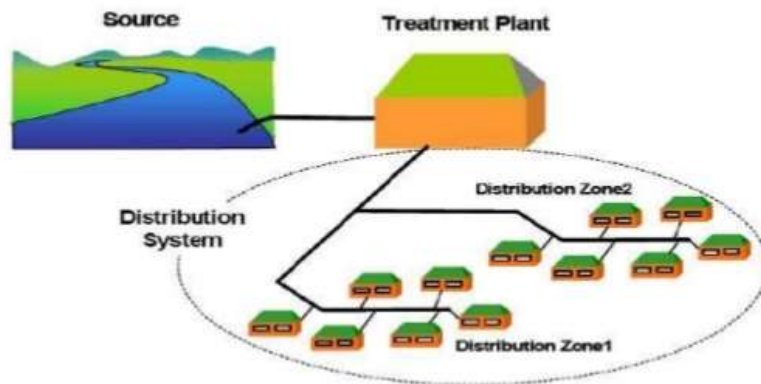

Disadvantages

Pipelines are likely to rust faster due to alternate wetting and drying. This increases the maintenance cost.

There is also pollution of water by ingress of polluted water through leaks during non-flow periods.

More wastage of water due to the tendency of the people to store more water than required quantity and to waste the excess to collect fresh water each time.

In spite of number of disadvantages, this system is usually adopted in most of the cities and towns of India. In this system water can be supplied in the high level localities with adequate pressure by dividing the city in zones. The repair work can be easily done in the non-supply hours.

SYSTEM OF DISTRIBUTION

For efficient distribution it is required that the water should reach to every consumer with required rate of flow. Therefore, some pressure in pipeline is necessary, which should force the water to reach at every place. Depending upon the methods of distribution, the distribution system is classified as the follows

- Gravity system
- Pumping system
- Dual system or combined gravity and pumping system

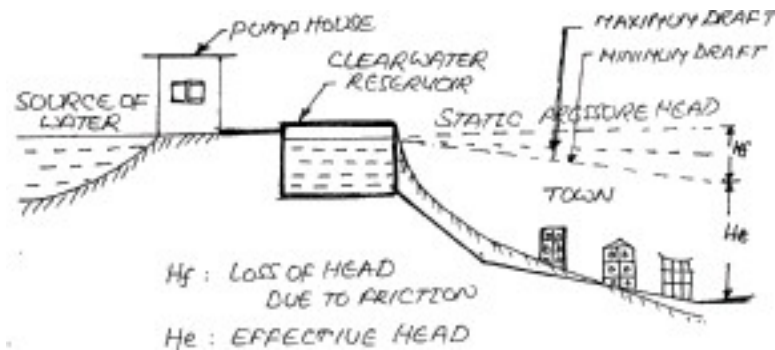

GRAVITY SYSTEM

When the ground level of water source/storage is sufficiently raised than the core village/town area, such system can be utilized for distribution. The water in the distribution pipeline flow due to gravity and no pumping is required. Such system is highly reliable and economical.



PUMPING STATION

In such system, water is supplied by continuous pumping. Treated water is directly pumped into the distribution main with constant pressure without intermediate storing. Supply can be affected during power failure and breakdown of pumps. Hence, diesel pumps also in addition to electrical pumps as stand by to be maintained. Such system works only in condition where there is continuous power supply, reliable water source and where intermediate storage system cannot be installed.

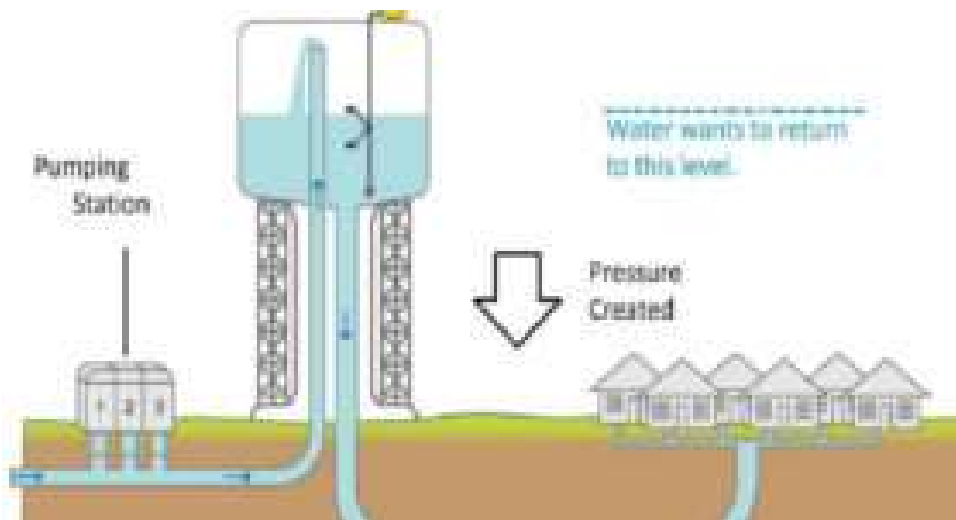
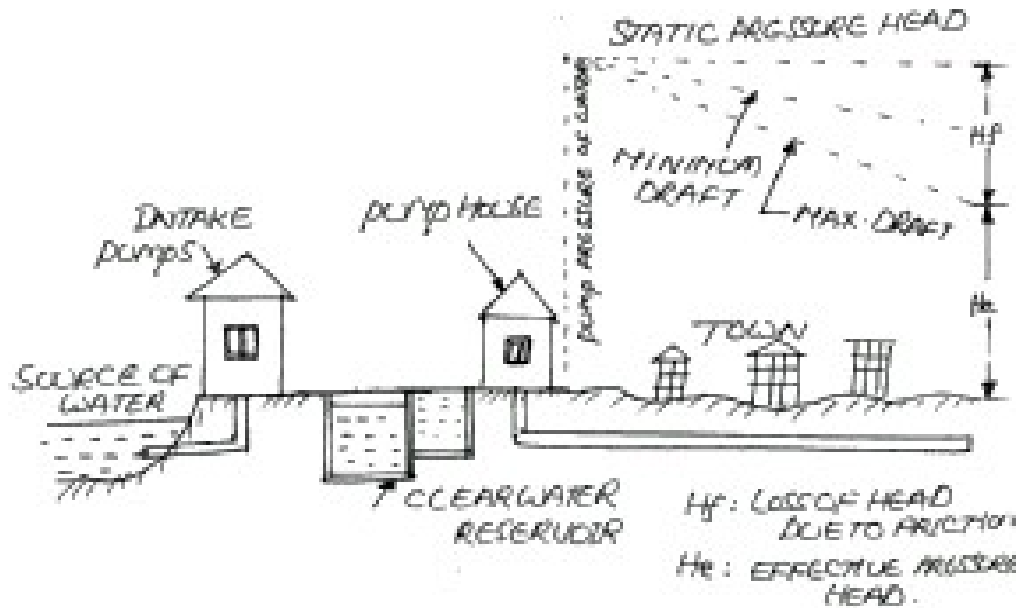

DUAL SYSTEM OR COMBINED GRAVITY AND PUMPING SYSTEM

This is also known as dual system. The pump is connected to the mains as well as elevated reservoir. In the beginning when demand is small the water is stored in the elevated reservoir, but when demand increases the rate of pumping, the flow in the distribution system comes from the both the pumping station as well as elevated reservoir. As in this system water comes from two sources one from reservoir and second from pumping station, it is called dual system. This system is more reliable and economical, because it requires uniform rate of pumping but meets low as well as maximum demand. The water stored in the elevated reservoir meets the requirements of demand during breakdown of pumps and for fire fighting.

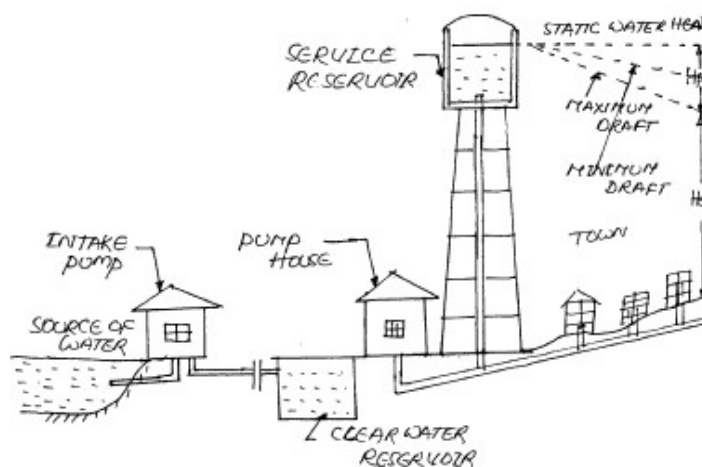

Minimum Residual Pressure in a distribution system should be 7 m for single storied, 12 m for two storied and 17 m for three storied building.

PIPES

Pipes convey raw water from the source to the treatment plants in the distribution system. Water is under pressure always and hence the pipe material and the fixture should withstand stresses due to the internal pressure, vacuum pressure, when the pipes are empty, water hammer when the valves are closed and temperature stresses.



REQUIREMENTS OF PIPE MATERIAL

- It should be capable of with standing internal and external pressure
- It should facilitate easy joints
- It should be available in all sizes, transport and erection should be easy
- It should be durable
- It should not react with water to alter its quality
- Cost of pipes should be less
- Frictional head loss should be minimum
- The damaged units should be replaced easily.

TYPES OF PIPES

- Cast Iron
- Steel
- Prestressed concrete
- R.C.C
- A.C. Pipes
- Galvanised Iron (G.I)
- P.V.C and plastic pipes

Various types of pipes are used for water supply system including metallic and non-metallic pipes. Most common types of pipes used for water supply system are:

- a. Galvanised Iron Pipes – metal pipe
- b. Mild Steel Pipes metal pipe
- c. Poly Vinyl Chloride pipes - non- metal pipe
- d. High Density Poly Ethylene Pipes - non metal pipe
- e. Ductile Iron Pipes

1. Mild Steel Pipes

- Number of joints are less as they are available in longer length.
- Pipes are durable and can resist high internal water pressure and highly suitable for long distance high pressure piping.
- Flexible to lay in certain curves.
- Light weight and easy to transport. Damage in transportation is minimal.
- Pipes are prone to rust and require higher maintenance.
- Require more time for repairs and not very suitable for distribution piping.
- Available in diameter of 150-250 mm for water supply and cut lengths of 4 - 7 m (2.6-4.5 mm wall thickness).
- Steel Pipes are joined with flanged joints or welding.



2. Galvanised Iron (GI) Pipes

- Cheap in cost and light in weight.
- Light in weight and easy to join.
- Affected by acidic or alkaline water.
- GI pipes are highly suitable for distribution system. They are available in light (yellow colour code), medium (blue colour code) and heavy grades (red colour code) depending on the thickness of pipe used. Normally, medium grade pipes (wall thickness 2.6-4.8 mm) are used for water supply system. Normally, 15-150 mm size pipes (nominal internal diameter) are used for distribution system. They are available in length of 3 m.
- GI pipes can be used in non-corrosive water with pH value greater than 6.5.
- GI pipes can be used for rising main as well as distribution.
- GI pipes are normally joined with lead putty on threaded end.



3. Poly Vinyl Chloride (PVC unplasticised) Pipes

- Cheap in cost and light in weight.
- Economical in laying and jointing.
- They are rigid pipes.
- Highly durable and suitable for distribution network.
- Free from corrosion and tough against chemical attack.
- Good electric insulation.
- Highly suitable for distribution piping and branch pipes.
- Less resistance to heat and direct exposure to sun. Hence, not very suitable for piping above the ground.
- PVC pipes weigh only 1/5th of steel pipes of same diameter.
- Certain types of low quality plastic impart taste to water.
- Available in size 20-315 mm (nominal internal diameter) for water supply with pressure class of 2.5, 4, 6, 8 & 10 kg/cm² for water supply. Ideally pipes with 6 kg/cm² should be used.



4. HDPE

- Light in weight.
- Flexible than PVC pipes.
- HDPE pipes are black in colour.
- Suitable for underground piping and can withstand movement of heavy traffic.
- Allows free flowing of water.
- Highly durable and suitable for distribution network.
- Free from corrosion
- Good electric insulation.
- Useful for water conveyance as they do not constitute toxic hazard and does not support microbial growth.



Normally, 20-315 mm diameter pipes are used for water supply and distribution system with pressure ranging from 6-



5. Ductile Iron Pipes

- Ductile Iron pipes are better version of cast iron pipes with better tensile strength.
- DI pipes are prepared using centrifugal cast process.
- DI pipes have high impact resistance, high wear and tear resistance, high tensile strength, ductility and good internal and external corrosion resistance.
- DI pipes are provided with cement mortar lining on inside surface which provides smooth surface and is suitable for providing chemical and physical barriers to water. Such pipes reduce water contamination.
- The outer coating of such pipes is done with bituminous or Zinc paint.
- DI pressure pipes are available in range from 80-1000 mm diameter in lengths from 5.5-6 m.
- Available in thickness class K7 and K9 with barrel wall thickness ranging from 5-13.5 mm. Also available in pressure class (Like C25, C30, C40 etc.).
- They are about 30 percent lighter than conventional cast iron pipes.
- DI pipes lower pumping cost due to lower frictional resistance.



What is spigot and socket end in pipes?

Spigot and sockets are type of pipe ends.

Spigot is the pipe end which is inserted into socket.

Spigot and socket are joined with rubber seals, lubricants etc.

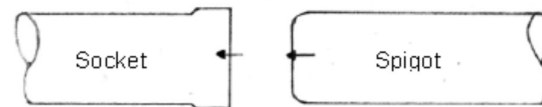

What is flanged end in pipes?

Pipes have flanged at their ends which are joined with nuts and bolts.

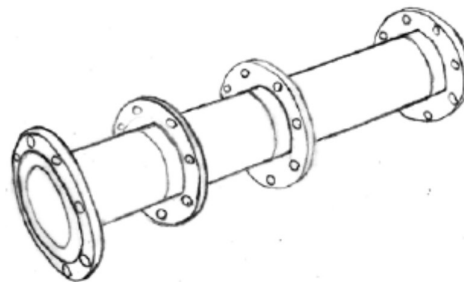

Sl.No.	Type of Pipe	Advantages	Disadvantages
1.	Cast iron Pipes	<ol style="list-style-type: none"> 1. Cost is moderate 2. The pipes are easy to join 3. The pipes are not subjected to corrosion 4. The pipes are strong and durable 5. Service connections can be easily made 6. Usual life is about 100 years 	<ol style="list-style-type: none"> 1. Breakage of pipes are large 2. The carrying capacity of these pipes decreases with the increase in life of pipes. 3. The pipes are not used for pressure greater than 0.7 N/mm² 4. The pipes are heavier and uneconomical beyond 1200 mmdia.
2.	steel Pipes	<ol style="list-style-type: none"> 1. No. of Joinings are less because these are available in long lengths 2. The pipes are cheap in first cost 3. The pipes are durable and strong enough to resist high internal water pressure 4. The pipes are flexible to some extent and they can therefore laid on curves 5. Transportation is easy because of light weight. 	<ol style="list-style-type: none"> 1. Maintenance cost is high 2. The pipes are likely to be rusted by acidic or alkaline water 3. The pipes require more time for repairs during breakdown and hence not suitable for distribution pipes 4. The pipes may deform in shape under combined action of external forces
3.	Prestressed concrete pipes	<ol style="list-style-type: none"> 1. The inside surface of pipes can be made smooth 2. Maintenance cost is low 3. The pipes are durable with life period 75 years 4. No danger of rusting 5. These pipes donot collapse or fail under normal traffic 	<ol style="list-style-type: none"> 1. The pipes are heavy and difficult to transport 2. Repairs of these pipes are difficult 3. The pipes are likely to crack during transport and handling operations 4. There pipes are affected by acids, alkalies and salty

		loads	waters.
4.	R.C.C Pipes	<ol style="list-style-type: none"> 1. There are pipes are most durable with usual life of about 75 years 2. The pipes can cast at site work and thus there is reduction in transport charges 3. Maintenance cost is less 4. Inside surface of pipe can made smooth 5. No danger of rusting. 	<ol style="list-style-type: none"> 1. Transportation is difficult 2. Repair work is difficult 3. Initial cost is high 4. These pipes are affected by acids, alkalies and salty waters.
5.	A.C. Pipes	<ol style="list-style-type: none"> 1. The inside surface of pipes are very smooth 2. The joining of pipe is very good and flexible 3. The pipes are anticorrosive and cheap in cost 4. Light in weight and transport is easy 5. The pipes are suitable for distribution pipes of small size. 	<ol style="list-style-type: none"> 1. The pipes are brittle and therefore handling is difficult 2. The pipes are not durable 3. The pipes cannot be laid in exposed places 4. The pipes can be used only for very low pressures
6.	Galvanised Iron pipes	<ol style="list-style-type: none"> 1. The pipes are cheap 2. Light in weight and easy to handle 3. The pipes are easy to jion 	<ol style="list-style-type: none"> 1. The pipes are affected by acidic or alkaline waters 2. The useful life of pipes is short about 7 to 10 years.
7.	P.V.C. Pipes	<ol style="list-style-type: none"> 1. Pipes are cheap 2. The pipes are durable 3. The pipes are flexible 4. The pipes are free from corrosion 5. The pipes are good electric insulators 6. The pipes are light in weight and it can easy to mould any shape 	<ol style="list-style-type: none"> 1. The co-efficient of expansion for plastic is high 2. It is difficult to obtain the plastic pipes of uniform composition 3. The pipes are less resistance to heat 4. Sometypes of plastic impart taste to the water.

JOINING OF CI PIPES

Push-on joint for S&S end pipe

Lead caulking joint for S&S end pipe

Cement mortar joint for S&S end pipe

Flanged joint for flange end pipe

PIPE JOINTING

Clean completely the socket from outside and inside including groove for gasket. Remove excess paint and foreign material. Also clean the spigot from inside and outside. Check the chamfer is properly provided.

Take the correct gasket to be used. Insert the gasket in the groove provided in the socket properly.

Apply the lubricant on the chamfered end of spigot. Use sufficient quantity of lubricant

Align the pipes to proper alignment. Push the spigot end in to the socket until it is ensured that the spigot end reached to proper location.

Necessary deflection can be given to the assembly as per design. The finished joint and the cross-section details of the finished joint is shown in adjoining figure.

Align the pipes to proper alignment. Push the spigot end in to the socket until it is ensured that the spigot end reached to proper location.

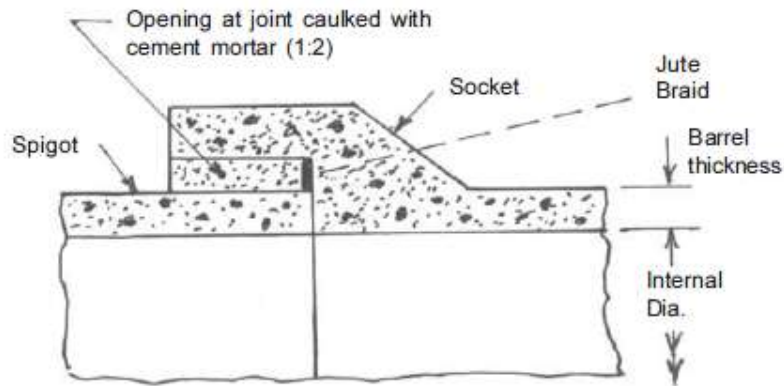

Rigid Joint- Spigot and socket ends

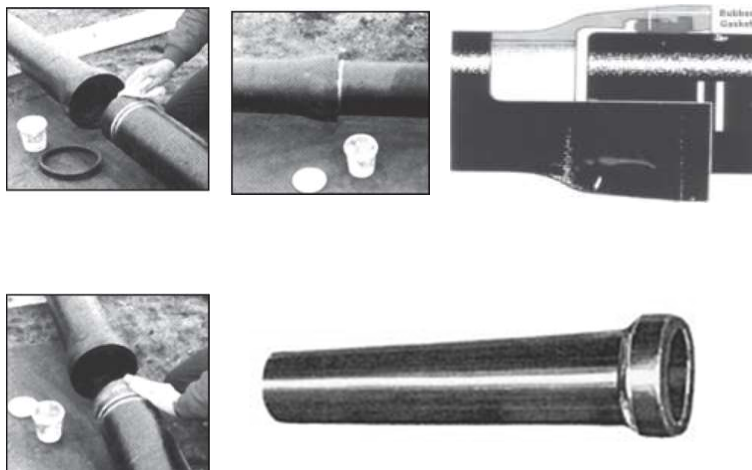

LEAD AND OAKUM JOINT

Cement mortar joint for S&S end pipe Same as lead joint except mortar 1:2 is used instead of lead

The spigot end is inserted into the socket right up to the back of the socket and carefully centered such that there is uniform annular space for filling with joining material.

The annular space between the socket and the spigot is filled with few turns of (Oakum) spun yarn formed into ropes of uniform thickness soaked in neat cement slurry.

The jointed pipeline shall be adjusted to required levels and alignment.

The lead shall be melted so as to be thoroughly fluid. Any scum or dross which may appear on the surface of the lead during melting, shall be skimmed off or removed.

The lead should have thoroughly melted by now and the joint shall be filled in one pouring. After lead has been poured into the joint, the lead shall be thoroughly caulked. Any lead outside the socket shall be removed with a flat chisel and then the joint caulked round three times with caulking tool and hammer.

FLANGE JOINT

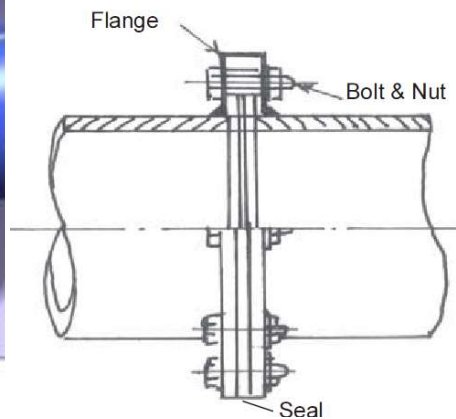
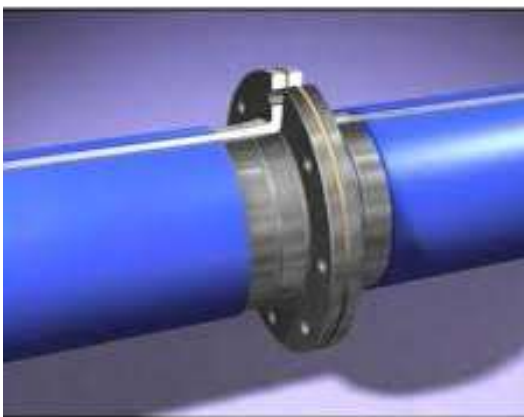
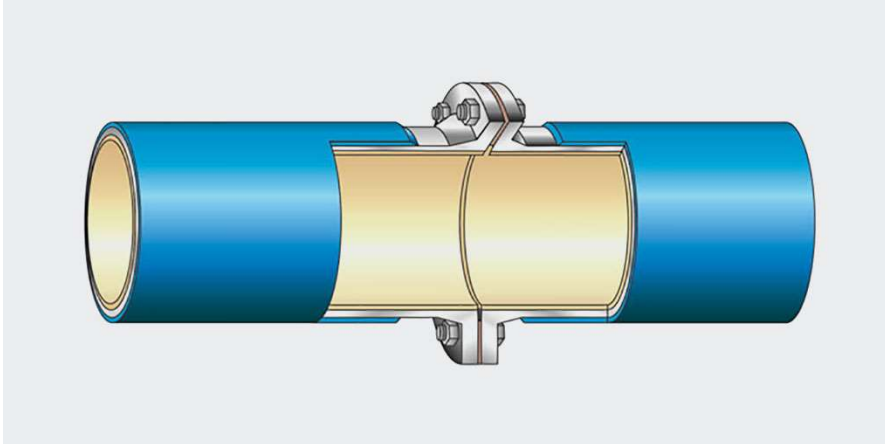

A flange is a perpendicular projection of a pipe. Piping is manufactured with flanges or they are to be attached by welding to the pipe as a separate operation.

This projection is sufficiently long enough to allow holes drilled in the a seal or gasket is placed between two pipe flanges to assure proper seating of the mating surfaces. Bolts are inserted through each projection and pipes are secured by tightening the nuts.

COLLAR JOINT



Spigot and socket joints (Flexible and rigid)

Collar joints (Rigid and semi flexible)

Flush joints (External and internal)

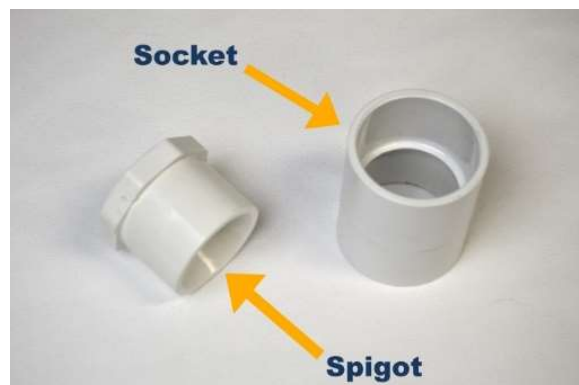
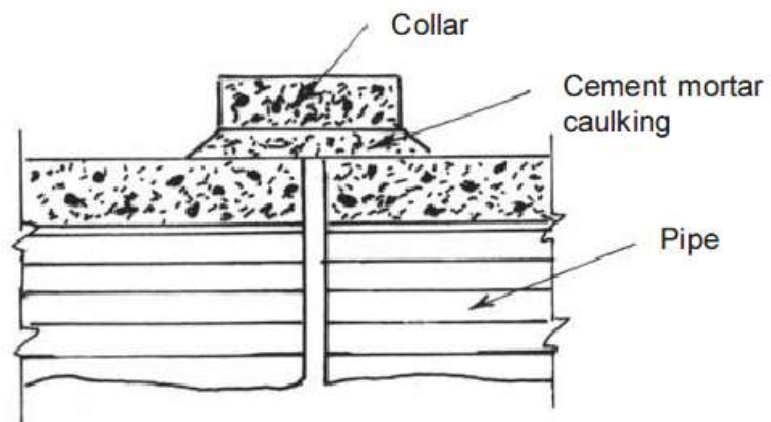

LAYING AND FIXING PIPELINES ABOVE GROUND

Laying of Socket and Spigot joint pipes over the ground

While laying the socket and spigot joint pipes over a normal ground, proper support should be provided over a distance not more than 8m apart. Similarly while crossing a water way additional support should be provided at a distance of 1.5 m on both the sides of the waterway. Figures shown below displays the supporting positions.

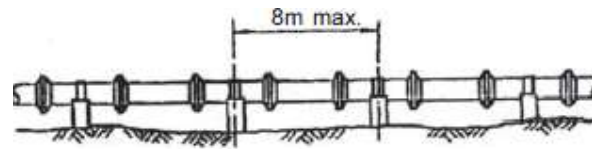

Pipes above normal level

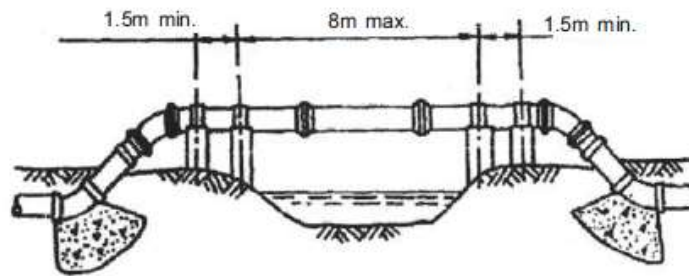

Socket and spigot pipes crossing water course

LAYING AND FIXING PIPELINES ABOVE GROUND

Laying of Flanged pipes over the ground

The flanged joints are provided at a distance of 4 m to 6 m apart. The support should be provided near each joint symmetrically. Figures shown below display the supporting positions.

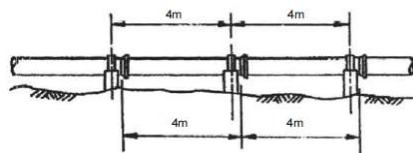
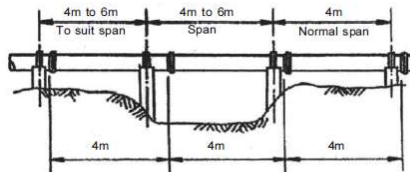

Flanged pipes over normal ground

LAYING AND FIXING PIPELINES BELOW GROUND

Pipelines carrying water are laid 0.6m to 1m below the ground surface. Just before covering the trench with the earth, the pipe joints are to be tested for leakage. Joints are inspected visually during the test and re-laid wherever required.

Pressure of pumping mains are tested for 1 1/2 times the operating pressure in the pipe for 24 hours. The pressure is increased gradually at the rate of 1kg/cm²/minute. Loss of water by leakage is made up at not more than 0.1lit/mm of diameter of pipe per km per day for every 0.3N/mm² pressure applied

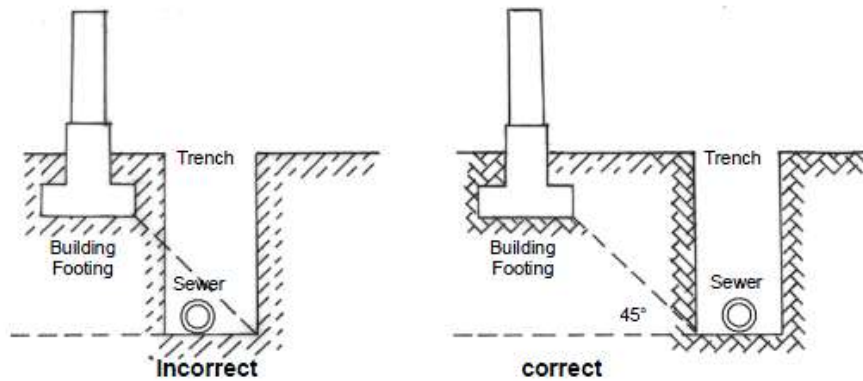

Location of pipe in trenches

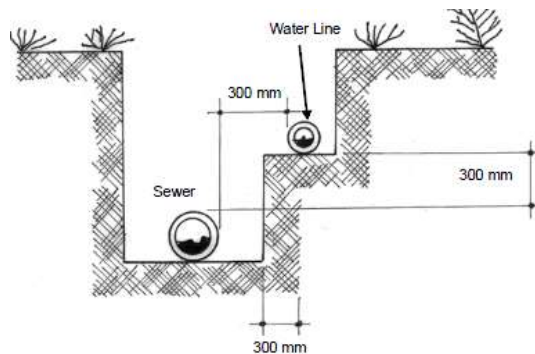

Minimum separation when sewer piping

LAYING AND FIXING PIPELINES BELOW GROUND

Preparation Prior to Laying of Pipes

Carry out line out as per need and plan with line out tools.

Maintain exact stipulated levels and gradient for laying the pipelines with leveling tools. Difference in level may disrupt the flow of water or pressure at the end point.

Excavate trenches for laying under ground pipelines. Trenches should be excavated with 600 mm width and 1000-1200 mm depth. Minimum clearance of about 150-200 mm is required on either sides of pipes in trenches.

Type of pipe	Minimum cover below road (mm)	Minimum clearance from either side of pipe in trenches (mm)
Steel (MS/GI/DI)	1200	200
Plastic (PVC/HDPE)	1000	200

LAYING AND FIXING PIPELINES BELOW GROUND

Maintain levels after excavation. Place extra formworks and shuttering where needed in case the soil is soft to prevent collapse of soil. If excavation is done more than planned size, fill it with the soil and compact it. If the soil is hard or rocky the depth may be reduced. In hard rock, use blasting for excavation.

If excavation is not possible, PVC pipes should be encased in masonry/concrete or steel pipes to prevent breakage and pressure of moving vehicles.

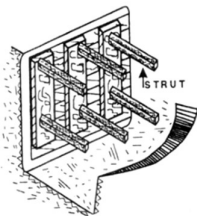
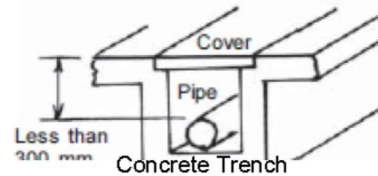

Method of supporting trench walls in soft soils

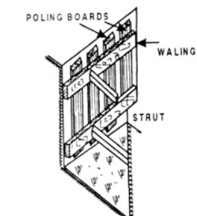

Method of supporting trench walls in moderate firm soils

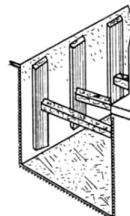

Method of supporting trench walls in firm soils

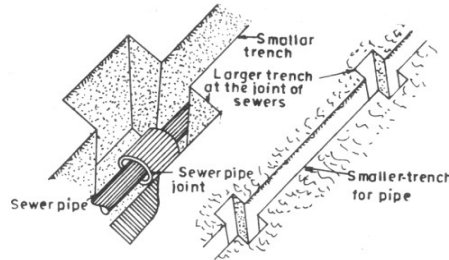
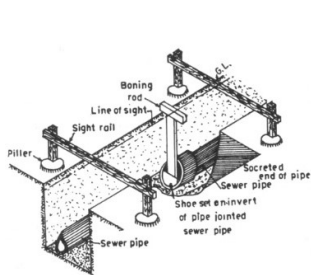

LAYING AND FIXING PIPELINES BELOW GROUND

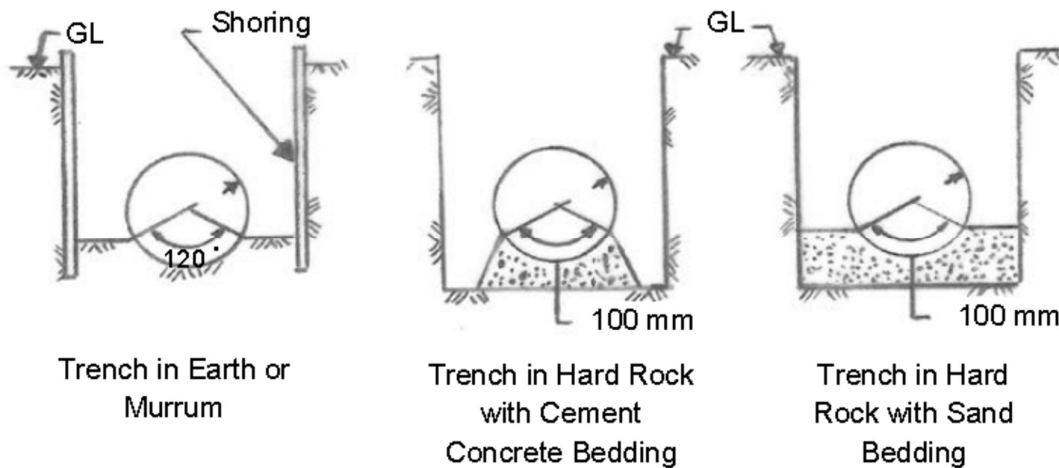

WATER SUPPLY PLUMBING SYSTEMS IN BUILDING AND HOUSES

It is necessary to know the following terms relating to plumbing, principles and the common practices used in the house plumbing

1. **Water main:** A water supply pipe vests in the administrative authority for the use of public or community
2. **Ferrule:** It is gunmetal or bronze screwed into the hole drilled in CI pipe mains. Communication pipe takes off from the ferrule. The pressure in the domestic supply and equal distribution among the house connection are effected by adjusting the ferrule opening.
3. **Saddle:** it is used in place of ferrule for mains of AC or PVC pipes
4. **Communication pipes:** It is a pipe taking off from the ferrule for the house connection. It is owned and managed by the water supply authority. Communication pipe terminates at the boundary of the consumers premises.
5. **Service pipe :** it is the part of the house connection beyond the stop cock. It is owned and maintained by the consumer . No pumps shall be installed on this pipe.
6. **Water meter:** It is installed to measure the flow. It is an integrating meter that it records the total flow up to the time of measurement. Generally 12.5 mm to 18.75mm rotary water meters are installed either at the beginning or at the middle of the service pipe. A masonry pit is constructed around it. It has facility of sealing by the water supply authority
7. **Goose Nech:** It is the short bent pipe and allow for small changes in length due to expansion and movement of pipes due to soil settlements

WATER SUPPLY PLUMBING SYSTEMS IN BUILDING AND HOUSES

THE HOUSE WATER CONNECTIONS

The house water connection is as shown in the fig

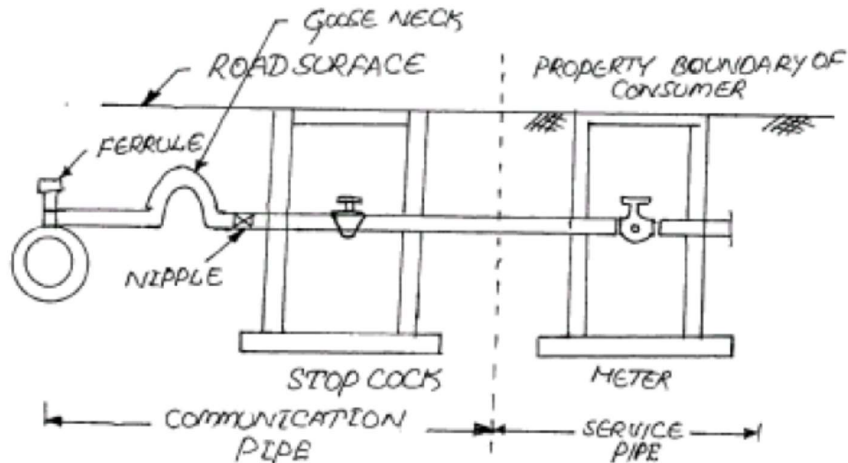

House water connection

WATER SUPPLY PLUMBING SYSTEMS IN BUILDING AND HOUSES

WATER PIPING SYSTEM IN BUILDING

The following are the requirements of piping system in building

1. Plumbing of water lines should be such as not to permit backflow from cisterns and sinks.
2. All joints shall be perfectly water tight and no leakage or spill at taps or cocks should be allowed.
3. Pipelines should not be carried under walls or foundations
4. It should not be close to sewers or waste water drains. There should not be any possibility for cross connections
5. When pipelines are close to electric cables proper precautions for insulation should be observed
6. Plumbing lines should be such as to afford easy inspection and repair of fixtures and joints
7. Number of joints should be less and number of bends and tees should be less
8. It should supply adequate discharge at fixtures, economical in terms of materials and protected against corrosion, airlock, negative pressure and noise due to flow in pipes and in flushing.

INTRODUCTION

Wholesome water

Absolutely pure water is never found in nature

But the water found in nature contains number of impurities in varying amounts. The rainwater which is originally pure, also absorbs various gases, dust and other impurities while falling. This water when moves on the ground further carries silt, organic and inorganic impurities.

Wholesome water is defined as the water which containing the minerals in small quantities at requisite levels and free from harmful impurities. The water that is fit for drinking safe and agreeable is called **potable water**.

The following are the requirements of wholesome water.

- It should be free from bacteria
- It should be colourless and sparkling
- It should be tasty, odour free and cool
- It should be free from objectionable matter
- It should not corrode pipes
- It should have dissolved oxygen and free from carbonic acid so that it may remain fresh

UNDERSTAND THE VARIOUS APPURTENANCES IN A DISTRIBUTION SYSTEM

The various devices fixed along the water distribution system are known as appurtences

- To control the rate of flow of water
- To release or admit air into pipeline according to the situation
- To prevent or detect leakages
- To meet the demand during emergency and
- Ultimately to improve the efficiency of the distribution

The following are the some of the fixtures used in the distribution system are

- Values
- Fire hydrants
- water meter

VALVES

In water works practice, to control the flow of water, to regulate pressure, to release or to admit air, prevent flow of water in opposite direction valves are required.

The following are the various types of valves named to suit their function

1. Sluice valves
2. Check valves or reflex valves
3. Air valves
4. drain valves or Blow off valves
5. Scour valve

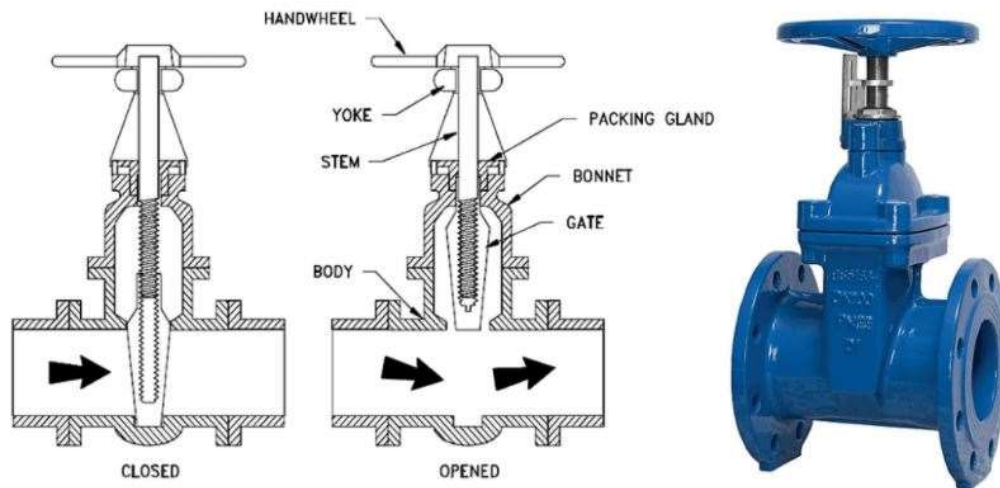

FIRE HYDRANT

A hydrant is an outlet provided in water pipe for tapping water mainly in case of fire. They are located at 100 to 150 m apart along the roads and also at junction roads. They are of two types namely.

Flush Hydrant & Post Hydrants

The post hydrant remain projected 60 to 90cm above ground level . They have long stem with screw and nut to regulate the flow. In case of fire accident , the fire fighting squad connect their hose to the hydrant and draw the water and spray it on fire.

A good fire hydrant

Should be cheap

Easy to connect with hose

Easily detachable and reliable

Should draw large quantity of water

WATER METER

These are the devices which are installed on the pipes to measure the quantity of water flowing at a particular point along the pipe. The readings obtained from the meters help in working out the quantity of water supplied and thus the consumers can be charged accordingly. The water meters are usually installed to supply water to industries, hotels, big institutions etc. metering prevents the wastage of purified water.

Installation of Water Meters

- Installation manual is normally given by the meter supplier.
- Domestic Water Meters can be fixed at household level in case there is 24 hours supply and water tariff is collected based on actual water consumption.
- A masonry pit is constructed around the meter to protect it. A lid should be placed on pit for taking readings. The protective lid should normally be kept closed and should be opened only for reading the dial.
- Technical parameter for fixing of water meters
 - a) Water meters must be fitted in the right direction of flow and positioned to allow easy visibility for manually reading the meter and for viewing the serial number.
 - b) The length of pipe that accommodates the water meter must be completely filled with water immediately upstream and downstream of the meter under all operating conditions.
 - c) Install meter such that top of the meter is below the level of the communication pipes so that meters always contain water.
 - d) Water meters are to be located to avoid damage (eg. vehicles, livestock, vandalism, flooding) a protective box/masonry pit may be necessary in some situations.
 - e) Water meters are to be installed as close as practicable to the extraction point and must be located upstream of any valves (except air valves), tees, take offs, diversions or branches.
 - f) Water meters are to be installed above ground if possible and located outside of wells to allow for safe and easy meter reading. If a water meter is required to be located below ground, or down a well then it should not be deeper than 500 mm below ground level.
 - g) Water meters fitted onto PVC, or HDPE pipeline must be adequately supported by a concrete block, or fabricated steel bracing to ensure stability.

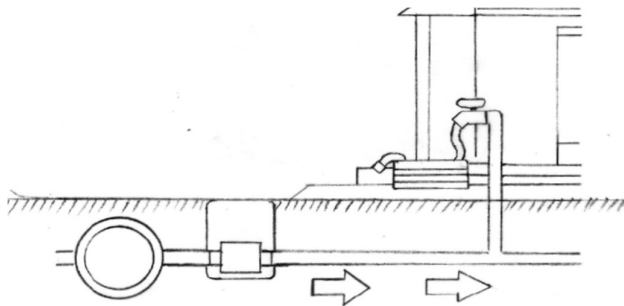

h) Before connecting the meter to the water pipe, it should be thoroughly cleaned by installing in the place of the water meter a pipe of suitable length and diameter and letting the passage of a fair amount of water flow through the pipe work to avoid formation of air pockets. It is advisable that the level of the pipeline where the meter is proposed to be installed should be checked by a spirit level.

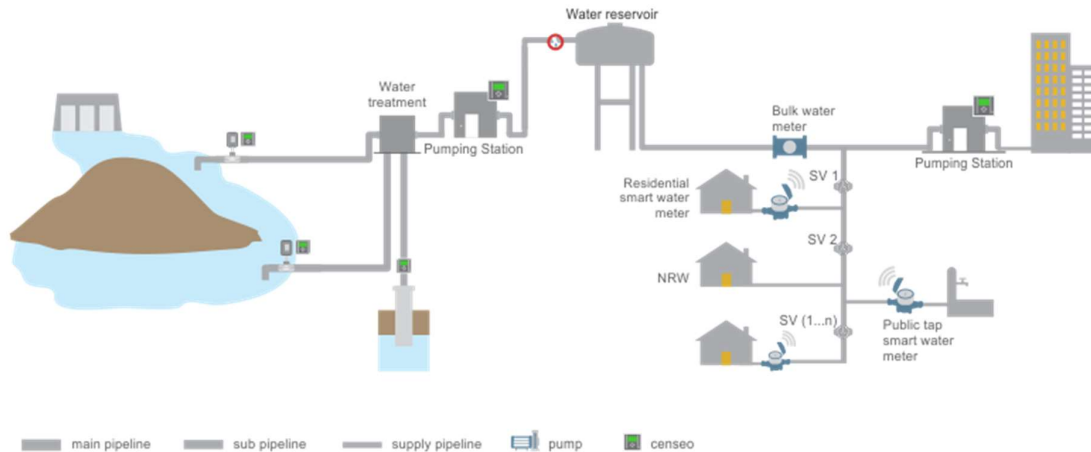

i) Before fitting the meter to the pipeline check the unions nuts in the tail pieces and then insert the washers. Thereafter screw the tail pieces on the pipes and install the meter in between the nuts by screwing. In order to avoid its rotation during the operation, the meter should be kept fixed with suitable non-metallic

clamps. Care should be taken that the washer does not obstruct the inlet and outlet flow of water.

j) Where intermittent supply is likely to be encountered the meter may be provided with a suitable air valve before the meter in order to reduce inaccuracy and to protect the meter from being damaged.

k) Test and calibrate the water meter before use and at regular intervals as per instructions given by manufacturer.

WATER DISTRIBUTION IN BUILDINGS

Up-Feed Water Distribution

To prevent rapid wear of valves, such as faucets, water should only be supplied to building distribution systems at pressures not more than about 80 psi. This pressure is large enough to raise water from 8 to 10 stories upward and still retain desired pressures at plumbing fixtures

Water pressure is not sufficient to provide adequate water pressure, the water pressure may be boosted to desired levels by the installation of a packaged, domestic water-booster pump system.

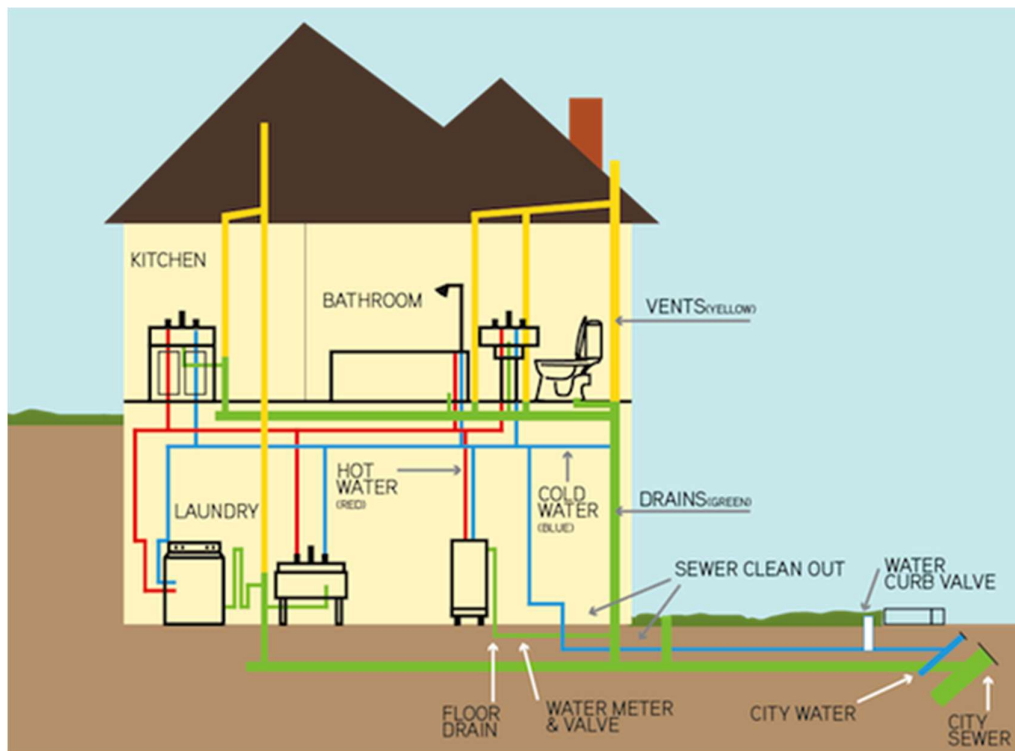
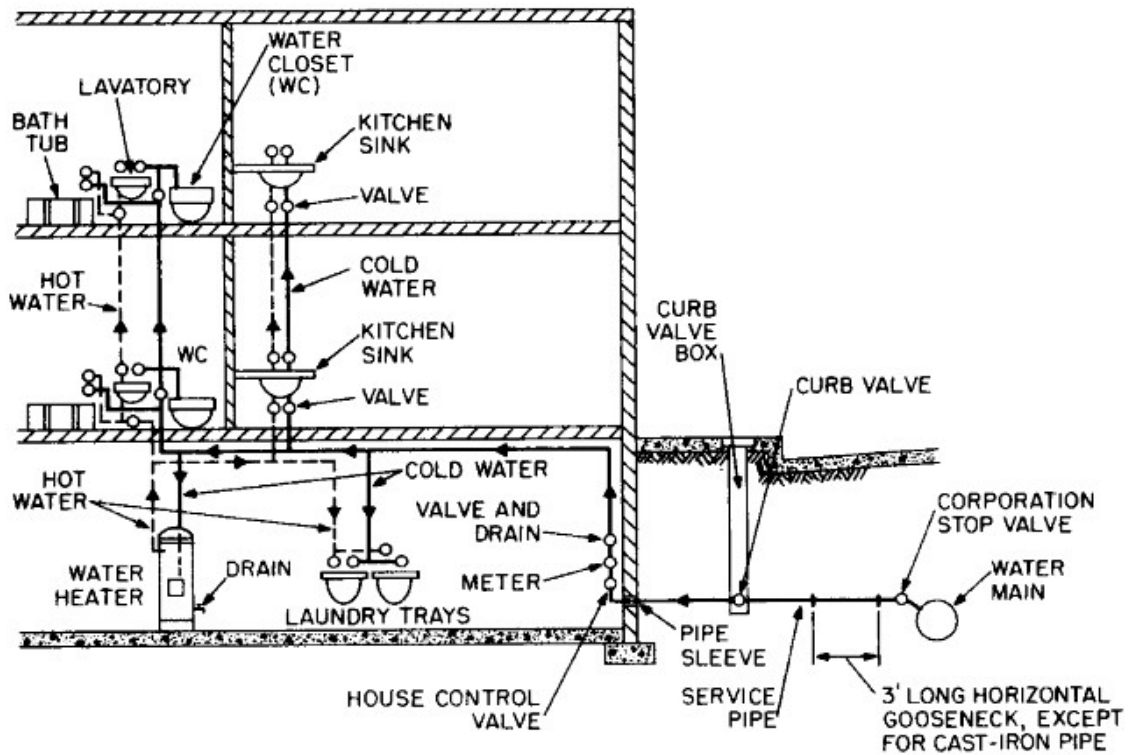

Down-Feed Water Distribution

For buildings more than 8 to 10 stories high, designers have the option to pump water to one or more elevated storage tanks, from which pipes convey the water downward to plumbing fixtures and water heaters.

The tank is partitioned to provide independent, side-by-side chambers, each with identical piping and controls.

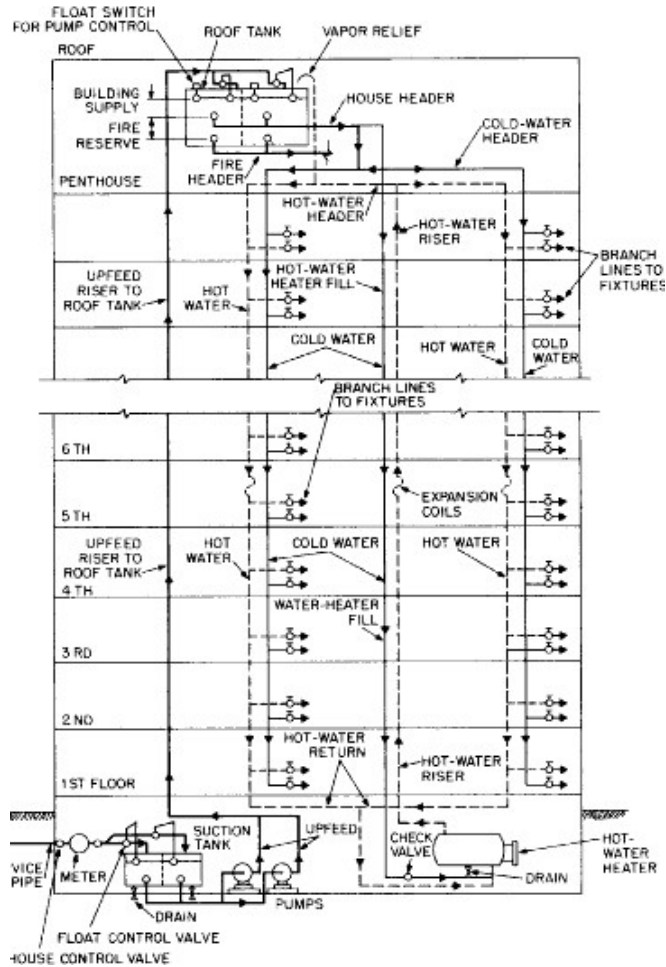

Down-Feed Water Distribution

For buildings more than 8 to 10 stories high, designers have the option to pump water to one or more elevated storage tanks, from which pipes convey the water downward to plumbing fixtures and water heaters.

tank is partitioned to provide independent, side-by-side chambers, each with identical piping and controls.

During hours of low demand, a chamber can be emptied, cleaned, and repaired, if necessary, while the other chamber supplies water as needed.

Float-operated electric switches in the chambers control the pumps supplying water to the tank. When the water level in the tank falls below a specific elevation, a switch starts a pump, and when the water level becomes sufficiently high, the switch stops the pump.

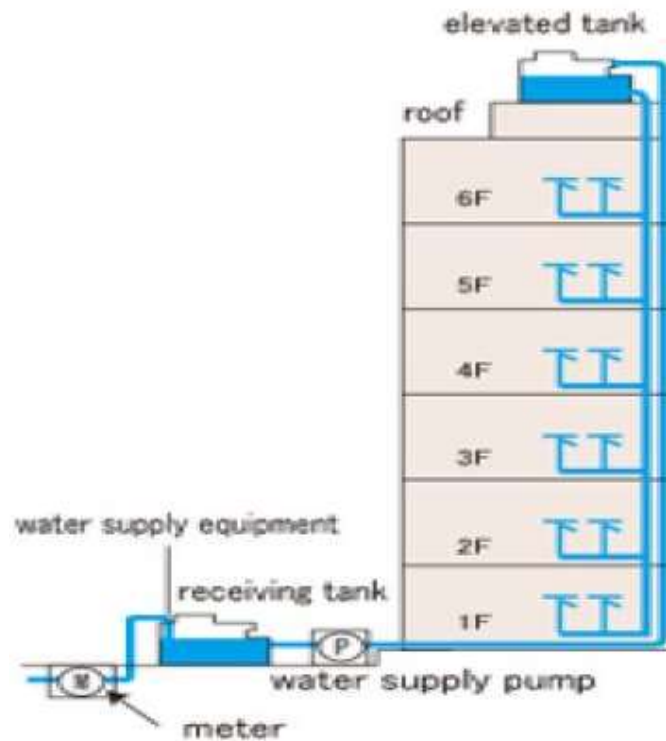

Distribution Systems in Multi-Storeyed Buildings

There are four basic methods of distribution of water to a multi-storeyed buildings.

Direct supply from mains to ablutionary taps and kitchen with WCs and urinals supplied by overhead tanks.

Direct Pumping Systems

Hydro-Pneumatic Systems

Overhead Tanks Distribution

Direct Supply

This system is adopted when adequate pressure is available round the clock at the topmost floor. With limited pressure available in most city mains, water from direct supply is normally not available above two or three floors.

Direct Pumping

Water is pumped directly into the distribution system without the aid of any overhead tank, except for flushing purposes.

The pumps are controlled by a pressure switch installed on the line. Normally a jockey pump of smaller capacity installed which meets the demand of water during low consumption and the main pump starts when the demand is greater.

The start and stop operations are accomplished by a set of pressure switches are installed directly on the line. In some installation, a timer switch is installed to restrict the operating cycle of the pump.

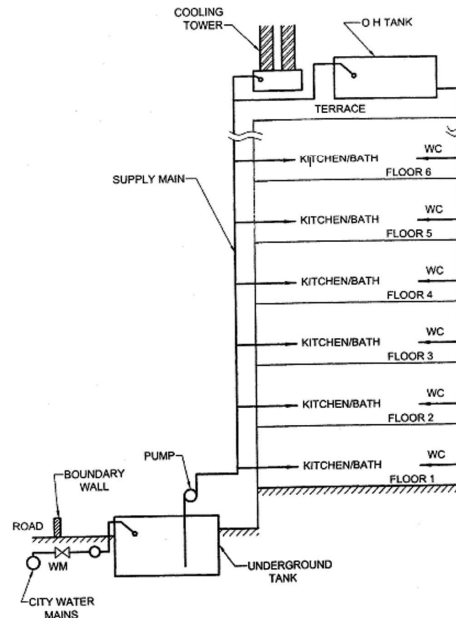

FIG. 6 DIRECT PUMPING SYSTEM APPLICABLE WHERE THERE IS CONTINUOUS DEMAND ON SYSTEM

PART 9 PLUMBING SERVICES—SECTION 1 WATER SUPPLY, DRAINAGE AND SANITATION

Distribution Systems in Multi-Storeyed Buildings

Hydro-pneumatic system

is a variation of direct pumping system. An air-tight pressure vessel is installed on the line to regulate the operation of the pumps.

The vessel capacity shall be based on the cut-in and cut-out pressure of the pumping system depending upon allowable start/stops of the pumping system.

As pumps operate, the incoming water in the vessel, compresses the air on top. When a predetermined pressure is reached in the vessel, a pressure switch installed on the vessel switches off the pumps.

As water is drawn into the system, pressure falls into the vessel starting the pump at preset pressure. The system shall have reliable power supply to avoid breakdown in the water supply.

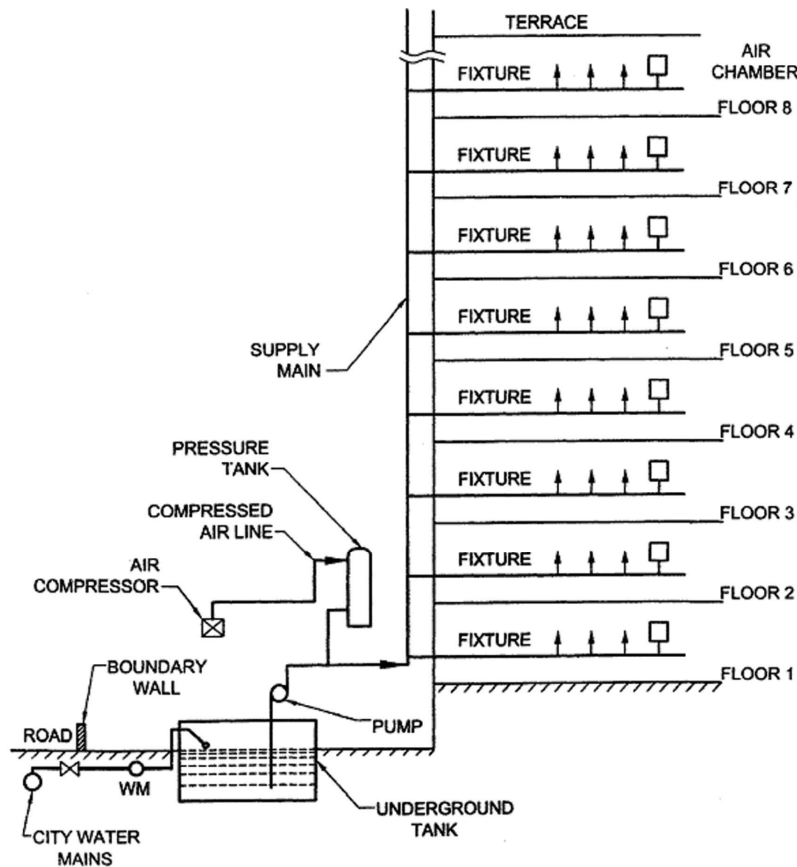

FIG. 7 HYDRO-PNEUMATIC SYSTEM

Distribution Systems in Multi-Storeyed Buildings

Over head Tank Distribution

This is the most common of the distribution systems adopted by various type of buildings.

The system comprises pumping water to one or more overhead tanks placed at the top most location of the hydraulic zone.

Water collected in the overhead tank is distributed to the various parts of the building by a set of pipes located generally on the terrace.

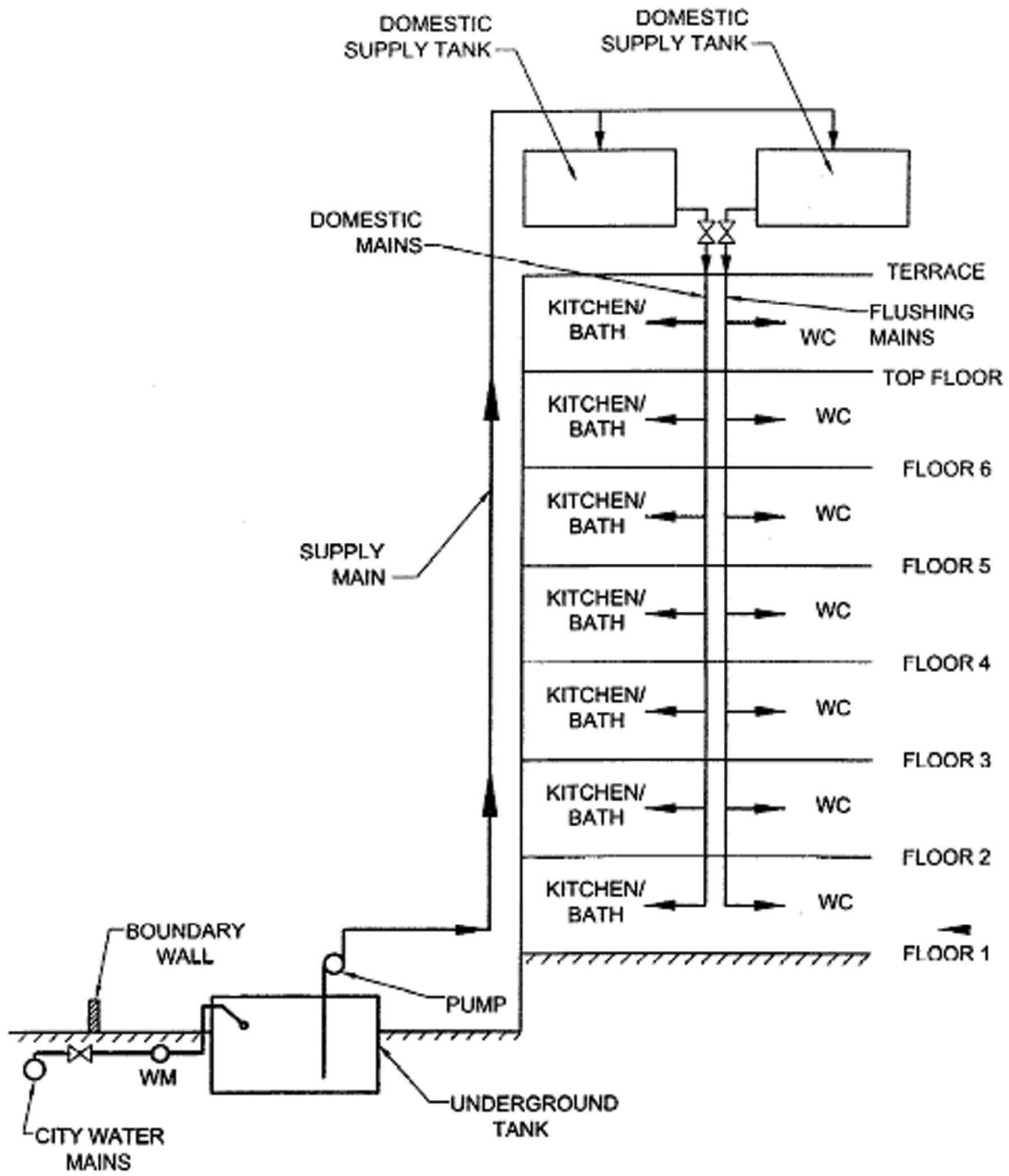

FIG. 8 OVERHEAD TANK DISTRIBUTION

PLUMBING SYSTEM

The system constitutes the following:

The water supply and water distribution system. Carries water from the water source, street main or a pump to the building and to various points in the building at which water is used.

The plumbing fixtures. The receptacles that receive the supplied water and allow the occupants of the building to use the water.

The drainage system. The piping network within the building which conveys from the plumbing fixtures all wastes and fecal matter (sanitary drainage) as well as rainwater (storm drainage) to a point of disposal or a treatment facility.

House Drainage

- The **W.C, Bathrooms, Sinks, Wash basins** are important components of a house. The occupants of the house make use of the above components and as a result of that there is a formation of waste water.
- The Waste water from W.C, bathrooms, sinks and wash basins is to be properly **disposed in to the municipal sewers.**
- It is therefore necessary to **construct a system of conveyance of wastewater** from W.C, bathrooms, kitchens and washbasins and disposal to the municipal sewer. This system is known as **house drainage system**

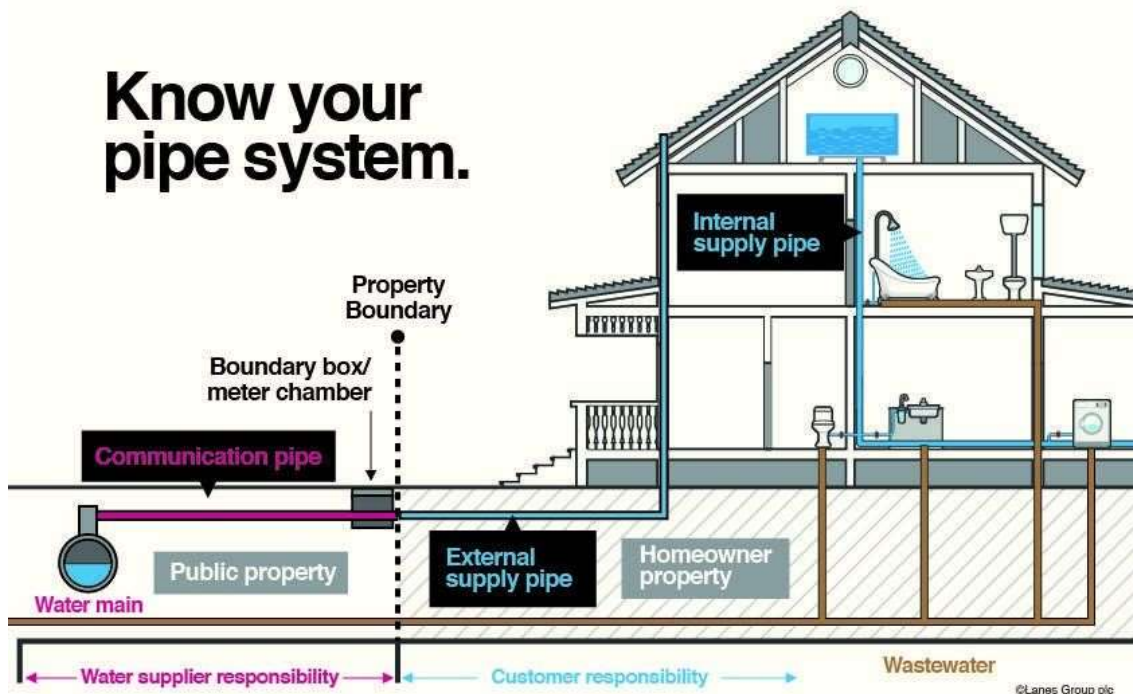

- Wastewater** Water when used for different purpose like domestic commercial, industrial etc., receives impurities and become wastewater. Thus wastewater is used water and it has **physical, chemical, and biological** Impurities in it. **wastewater is a general term.**
- Sewage** The waste water coming from W.C. and containing human excreta is known as sewage.
- Sullage** The Wastewater coming from bathrooms and kitchens which does not contain fecal matter is known as sullage.
- Plumbing System** It is entire system of pipe line for providing water supply to the building or it is a system of pipes for disposal of wastewater from the building.
- Sewer** A pipe carrying sewage/ wastewater is called sewer.
- Soil Pipe** It is pipe carrying sewage from W.C.
- Waste Pipe** It is a pipe carrying sullage from bathrooms, kitchens, sinks, wash basins, etc.
- Sewerage System** A system of sewers of different types and sizes in a town collecting wastewater from the town and carrying it to the wastewater treatment plant.
- Manhole** These are RCC/ Masonry chambers constructed at suitable intervals along sewer lines.
- Traps** Traps are defined as fittings at the end of soil pipes of waste pipes to prevent foul gases coming out of the soil pipe/ waste pipe.

Principles House Drainage

- House Drainage should be **preferable laid by side of the building** to facilitate easy repair and better maintenance.
- House sewer joints should be **leak proof** because leakage if any shall create an odour problem and leaked wastewater shall infiltrate in the ground and shall reduce **bearing capacity of soil** below foundation, which is not desirable.
- The sewage or sullage should **flow under the force of gravity**.
- The house sewer should **always be straight**.
- The entire system should be **well ventilated** from start to the end.
- The house sewer should be connected to the manhole such that the invert level is sufficiently higher to avoid back flow of sewage in house sewer.

- Where ever there is change in direction of sewer line in the premises, provide **inspection chamber at the junction.**
- **Rain water** from roofs or open courtyards **should not be** allowed to flow through the **house sewers.**
- **Siponage action** can never be permitted and therefore adequate **ventilation systems** should be installed.
- Sewer drains should be laid at a slope to achieve **self cleansing velocity of 0.6 -0.75 m/sec.**
- Sewer pipes should be at **least 900mm below the road and minimum 600 mm below the fields and gardens.**
- It should not be laid near foundation of buildings or near large trees.

SYSTEMS OF PLUMBING

- There are four systems adopted in plumbing of drainage work in a building
- Single stack system
- One pipe system
- One pipe system partially ventilated
- Two pipe system

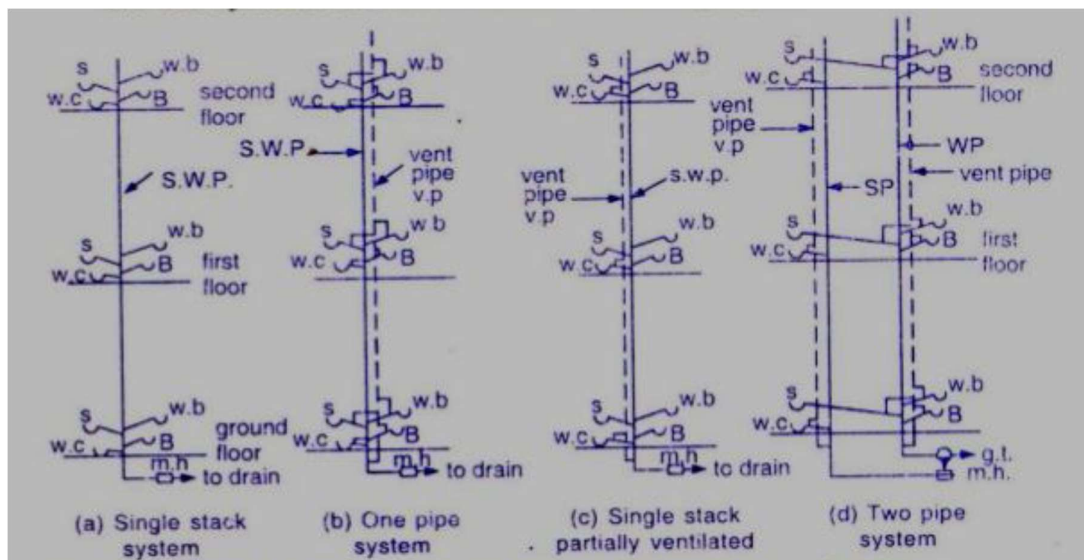

SINGLE STACK SYSTEM

This is a simplified one-pipe system without ventilation pipe work. The trap of water closet, sinks, basins, is directly connected to single stack.

The pipe, in addition, also acts as a vent pipe. The single stack system is economical

Single stack system has been found satisfactory in actual working if there is close grouping of sanitary appliances and short branches discharge soil and waste into the main stack in the direction of flow, there by minimizing the danger of loss of water seal of traps by induced siphonage.

The vertical distance between the waste water branch and we branch connection should be separated by minimum 200 mm when soil pipe is above waste water branch.

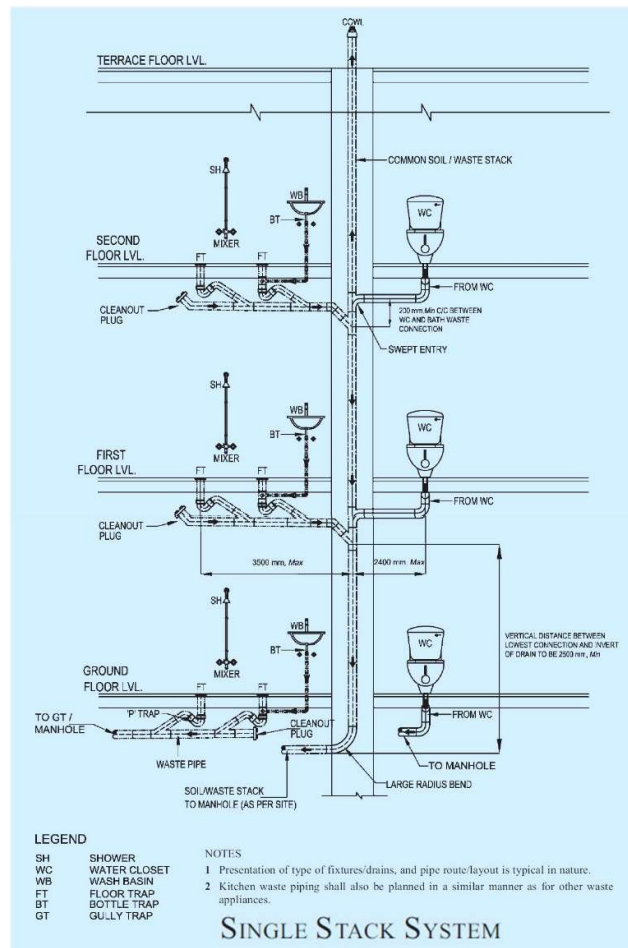

ONE PIPE SYSTEM PARTIALLY VENTILATED

In this, a single soil waste pipe conveys both soil and waste directly to the building drain.

A separate vent pipe is provided. Hence, it is more effective than the single stack system.

The vent pip provides ventilation to water seal of all the traps of Water Closets.

The term one pipe system is a misnomer as there are actually two stacks, one soil-cum-waste pipe, and the other vent stack.

This system is suitable for buildings when the toilet layout and the shafts are repetitive as it requires less space and is economical.

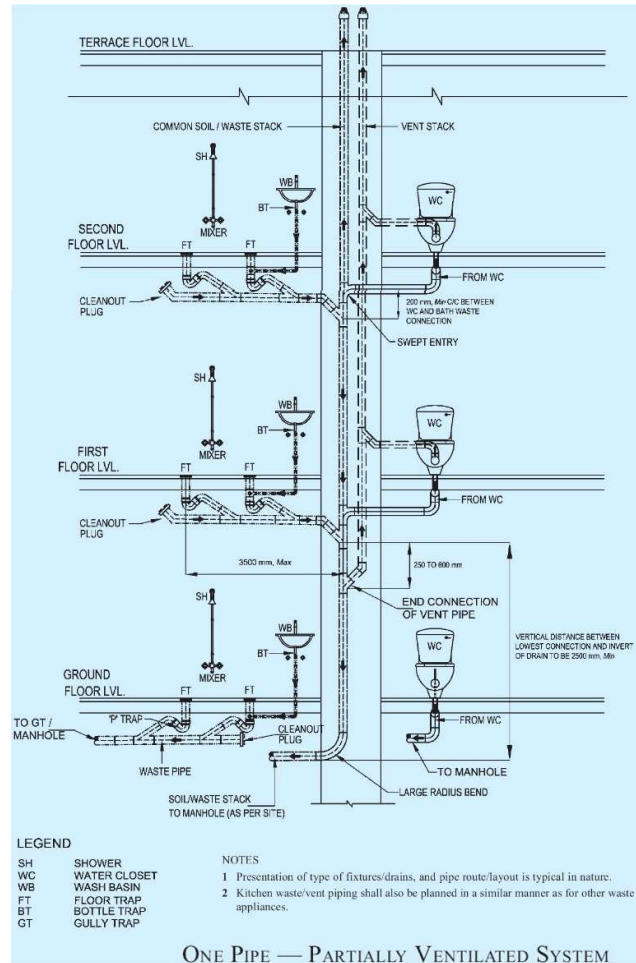

ONE PIPE SYSTEM FULLY VENTILATED

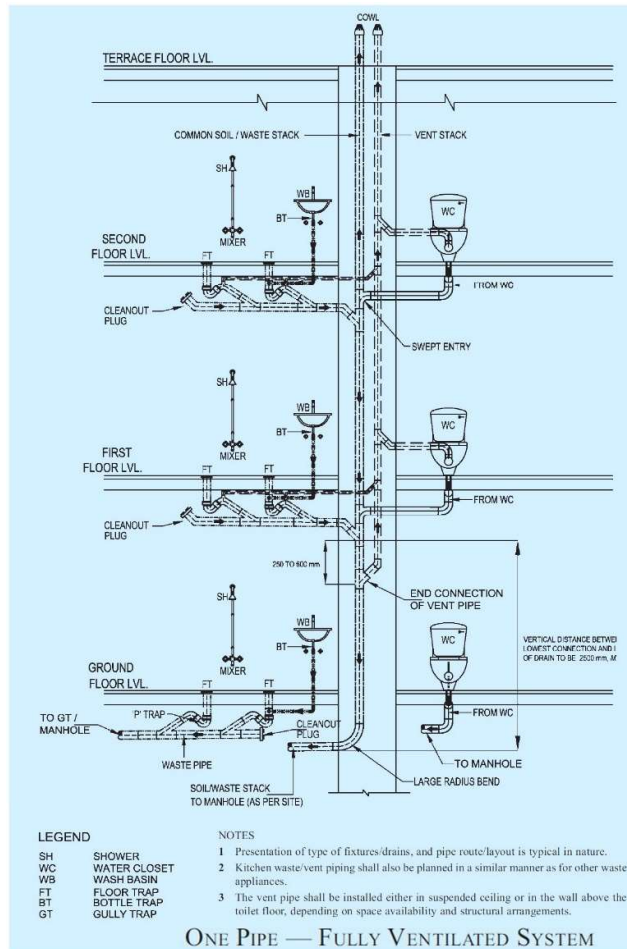

TWO PIPE SYSTEM WITH COMMON VENT PIPE

In this system of plumbing, the soil and the waste pipes are distinct and separate as shown in figure. The soil pipes are connected to the building sewer direct.

Waste pipes are connected to the building sewer through a trapped gully. The gully trap forms a barrier to the passage of foul air from the sewer into waste pipe.

All traps of soil appliances are completely ventilated through a separate ventilating pipe. Likewise traps of all waste appliances are completely ventilated through a separate ventilating pipe.

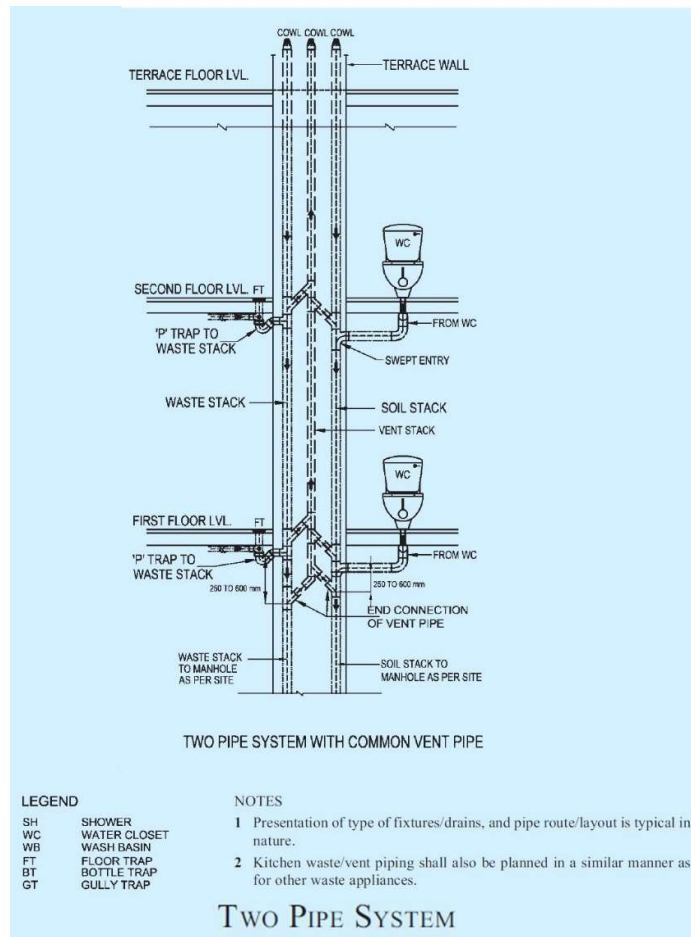

TWO PIPE SYSTEM WITH INDEPENDENT VENT PIPE

Thus this system of plumbing contains one soil pipe, one waste pipe and two (or one) ventilating pipes.

The two-pipe system is age-old and safe system, especially advantageous where the sullage (waste water) from waste appliances can be dealt with separately for use in gardening or other such purposes.

The two pipe system is proper system to adopt where fitments are scattered with water closet, baths and basins widely separated.

Due to unsightly and uneconomic web of pipes, this system is not much favored today.

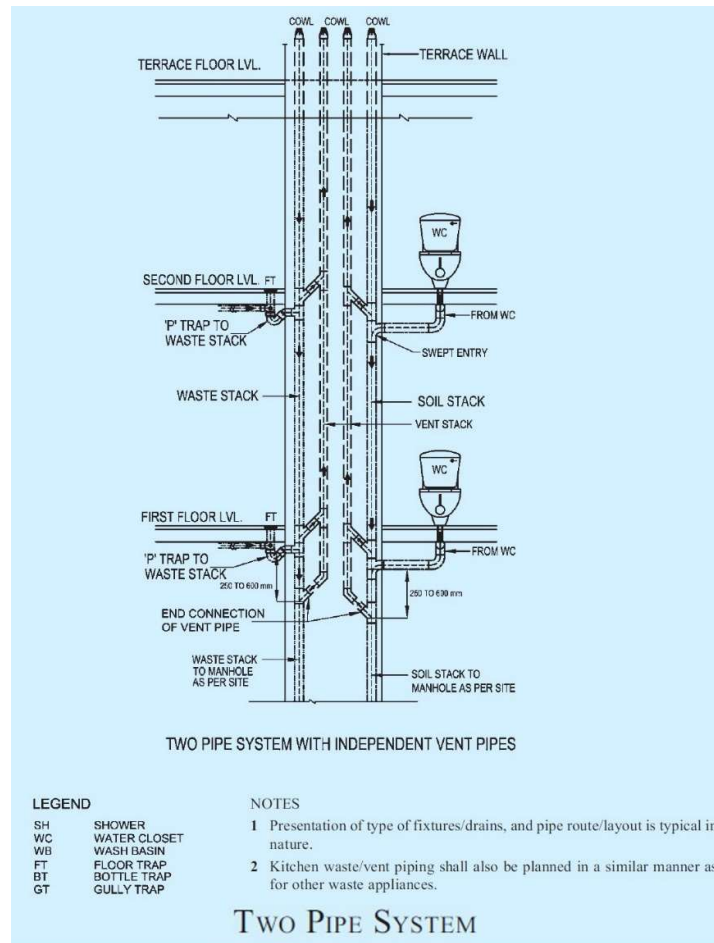

TRAP

A trap is a fitting provided in a drainage system to prevent entry of foul air or gases from the sewer or drain into the building. The barrier to the passage of foul air is provided by the water seal in the trap.

A trap is merely a double bend or loop in the sanitary fitting, the depth of water seal being the distance of the first bend and the bottom of the second.

The deeper the seal the more efficient is the trap.

The depth of the water seal varies from 40 to 75 mm.

The trap should always be fitted close to the waste or soil fitting unless the trap is an integral part of the fitting as in case of European WC (siphon type).

TYPES OF TRAPS

Depending upon the shapes the traps are classified as:

- **P-Trap**
- **Q-Trap**
- **S-Trap**

Above three types of traps are shown in the following figure

DEPENDING ON THE USE AND LOCATION

- Floor trap (Nahani trap)
- Gulley trap
- Intercepting trap
- Silt trap
- Grease and oil traps

Floor Trap (Nahani Trap)

Floor traps are provided in floors to collect waste water from kitchen sinks, bathroom floors, washing floors, etc. A floor trap forms the starting point of waste flow.

The trap is made of cast iron or PVC, provided with a removable grating at top so as to prevent the entry of solid matter. The depth of water seal of floor trap should not be less than 40 mm.

Gulley Trap

The gulley trap is usually situated near the external face of the wall. It disconnects the waste water flowing from kitchen, bathroom, wash-basin and floors from the main drainage system

This is a deep seal trap forming a barrier for preventing the foul gases from house drain to the inside of the building.

It is made of cast iron or glazed stoneware. Grating is provided on top to retain all solid matter. It is fitted in a small masonry enclosure to meet the requirements of invert levels of waste pipes discharging into the gulley trap.

The water seal of about 60 to 70 mm is provided in the gulley trap. Gulley trap is provided in the waste pipe only. The maximum distance between the gulley trap and the first manhole should be 6 m.

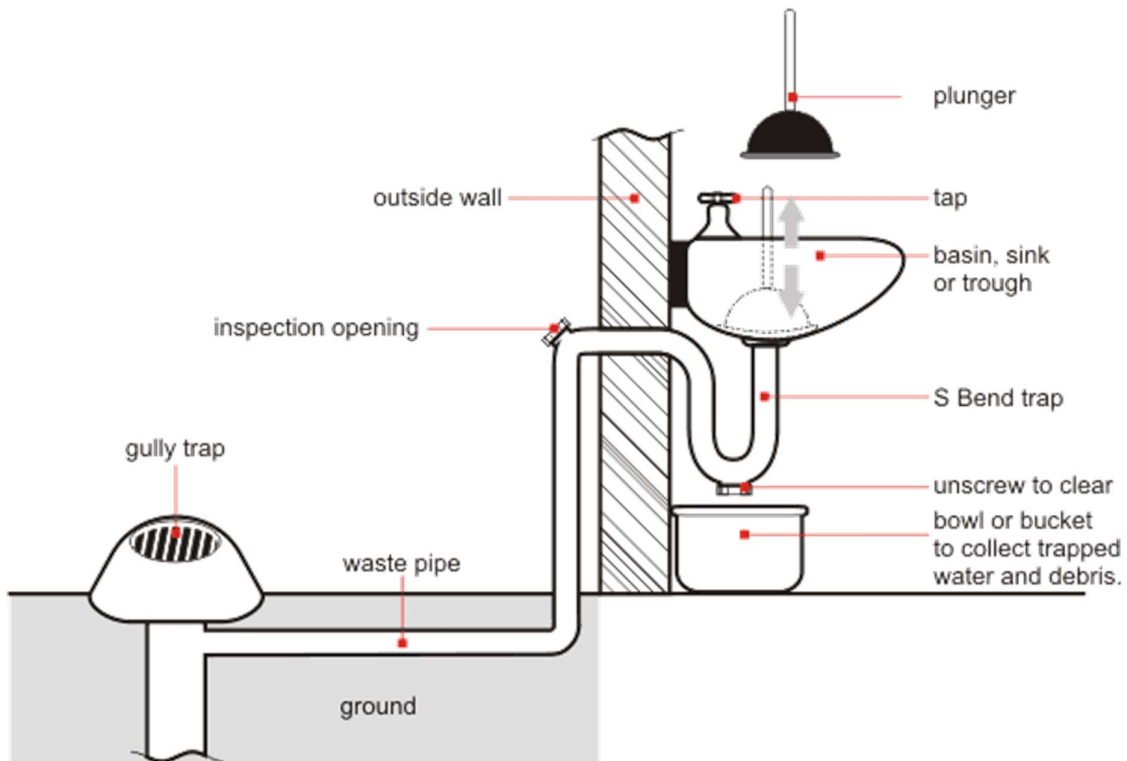

INTERCEPTING TRAP

This trap is provided at the last manhole, i.e. at the junction of house drain (inspection chamber) and the public sewer so as to prevent the entry of foul air from public sewers to the house drain.

The trap is made of glazed stoneware with an inspection arm for the purpose of cleaning or inspection. The inspection arm is kept closed by a lid or plug.

The water seal is deeper than that of normal traps (not less than 100 mm).

Though the use of intercepting trap is not essential; the provision of this trap is sometimes made compulsory by the local authority and thus it is a matter of policy of local authority.

GREASE AND OIL TRAPS

These are chambers provided on the sewer line to exclude grease and oil from sewage before it enters the sewer line. These traps work on the principle that grease or oil being light in weight float on the surface of sewage. Thus, the inlet pipe is near the top of the chamber and the outlet pipe is near the bottom.

The grease and oil traps are located near the sources contributing grease and oil to sewage like automobile repair workshops, grease and oil producing industries, garages, hotel kitchens, etc. If grease or oil is not removed, it sticks to the sides of sewer, reducing its capacity. Moreover, presence of grease or oil in sewer adversely affects the biochemical reactions during sewage treatment.

PLUMBING FIXTURES

TAPS

Taps fall into three main design categories, wall mounted taps are known as Bib Taps, those mounted directly onto the sink, basin or bath are called Pillar Taps, and thirdly there are Mixer Taps, which have a hot and cold valve linked to a single spout.

Traditionally, most taps used the Pillar design. These work by having a Rubber or Nylon (or leather) washer on a threaded pillar/spindle inside the body of the tap. When the tap is closed, the washer would sit on top of the water supply pipe. As the tap is unscrewed the whole pillar unscrews and rises with the washer, allowing the water to pass into the spout



TYPES OF TAPS

- BIB TAP
- PILLAR TAP
- CERAMIC DISC TAP
- SELF – CLOSING TAP
- BASIN PILLAR TAP

BIB TAP: It is a draw-off tap with horizontal inlet and free outlet. A bib tap is closed by means of disc carrying a renewable non-metallic washer which shuts against the water pressure on a seating at right angles to the axis of the threaded spindle which operates it.

The bib taps are provided with threads on the external side and have to be connected to a socket at the pipe out let.

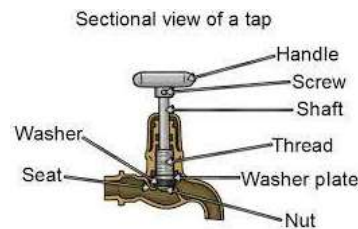

STOP VALVE

Stop Value is almost identical in function, except that it does not have a spout but it is inserted in a pipe line for controlling or stopping water flow. The stop valves are available in nominal sizes of 15,20,25,32,40 and 50 mm.

PILLAR TAP

The traditional spindle design is commonly used on lower quality, cheaper tap designs. The tap has a spindle through the centre, with the valve seat connected via a screw thread. A standard tap washer (either 15 mm or 20mm) is fixed to the end of the valve seat. As the handle is turned the spindle rotates and the screw thread moves the valve seat up and down to regulate the flow of water

These taps are very commonly used for all purposes but have following shortcomings,

- Difficult to operate - handle has to be turned many times from off to full on.
- Higher maintenance - washers will require replacing regularly
- Less choice of style - cannot be used with modern lever designs.

CERAMIC DISC TAPS

This technology is commonly used on more expensive taps, as they perform better and last longer. When the handle is turned, two ceramic discs are parted opening the valve and allowing the water to flow.

The one disc is in a fixed position and the other turns up to 90% with the handle. These two discs are aligned in the open position. This type is used in most superior taps and mixer valves, where the operation is by small turn or lift of the knob.

SELF-CLOSING TAP

A self-closing tap is a draw-off tap which remains in the open position so long as a lever handle is kept pressed up, down or sideways, or a pushbutton is kept pressed in, and closes by itself or when the button or the lever handle is released; the self-closing taps may incorporate a device which closes the tap even without the release of the button or the handle after a fixed quantity is discharged. These types of taps prevents wastage of water and are normally fixed at location where heavy public traffic is expected all the time

NOMINAL SIZE: - Self-closing taps shall be of the following nominal sizes. Nominal size refers to the nominal bore of the inlet connection. (15mm& 18mm)

The force required for operating the self-closing tap for its full opening should not exceed 70N.

MIXER VALVES

Hot and cold water is carried in different pipes and mixed in a mixer valve at the point of discharge, through a common spout.

MATERIAL USED FOR THE TAP

All sanitary appliances and their components shall be durable, impervious, and corrosion resistant and have smooth surface which may be easily cleaned. They shall conform to relevant Indian Standard where they exist, otherwise they shall be of the best quality and workmanship which shall be approved by a competent authority. Taps can be made from a variety of materials of varying quality and cost. A general rule of thumb is that the heavier the tap the better the quality of materials used. Some other materials along with suitable coatings are also used for manufacturing the taps apart from plastic and brass given below.

PLASTIC TAP

Plastic taps are very cheap and generally low quality. They are very light and are available in a range of colors. 15 mm and 20 mm are the normal sizes of plastic taps available. Now a days superior quality plastic taps are also manufactured with GFN (Glass filled Nylon). They are to be manufactured as per IS:9763 and are suitable for use up to 1MPa pressure and water temperatures 90°C. However the recommended temperature for use is 65°C.

BRASS TRAP

Standard brass is commonly used to manufacture the bodies of mid- priced, medium quality taps.

Many tap components (such as handles) can be made from plastic. These are cheaper than using brass, and whilst the quality is often very good, brass offers a better finish and longevity.

WASH BASINS & SINKS

A Wash basin is made up of vitreous china and is available in wide range of colors, patterns and sizes. Washbasins are of one piece construction including a combined overflow and soap holder.

An overflow slot, if provided, shall have a horizontal dimension not larger than 64 mm and an area not less than 500 mm². A round overflow of the same area can be an alternate design.

The soap recess(es) shall have adequate provision for draining into the bowl. All internal angles are designed so as to facilitate cleaning.

The sinks are also the similar construction as wash basins, except that the size of sinks is much larger and the bottom surface is level/flat compared to rounded shape for wash basins

CONSTRUCTION

Wash basins are provided with five, three, two or single tap hole, round in shape and symmetrical about the centre line of the basin and either fully punched or semi-punched. The tap holes shall be suitable for fixing pillar taps conforming to IS 1795:1982 or to IS 893:1993. The level of the top of the platform which accommodates the taps is not to be below the spillover level of the basin irrespective of the overflow arrangement.

Each basin shall have a circular waste hole. The waste hole shall accommodate a waste fitting having a flange diameter of 64 mm (IS 2963:1979).

Each wash basin has a rim on all sides, except sides in contact with the wall and has a skirting at the back. The entire flat surface should have sloped inside towards the bowl.

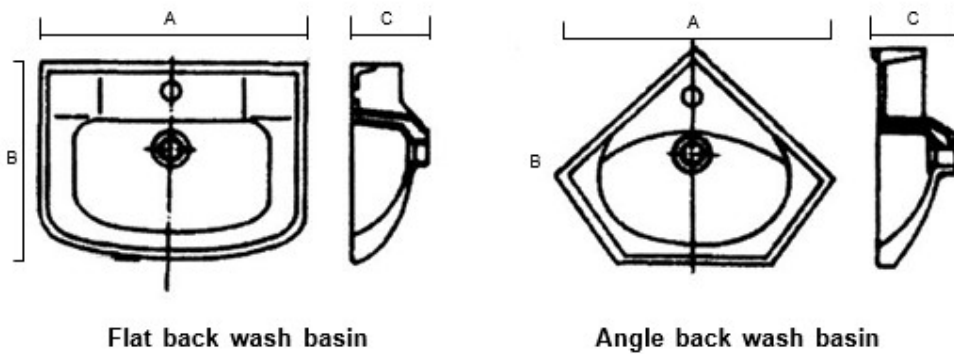

WASHBASIN TYPES

Wash basins can be broadly classified as :-

- 1) **Wall hung** or 2) **Counter fitted**.

Wall hung wash basins are further classified as

- **Flat back**
- **Angle back**
- **Full pedestal**

Counter fitted wash basin are further classified as

- **Under the counter**
- **Over the counter**

Counter top

Layout of Toilet - Section

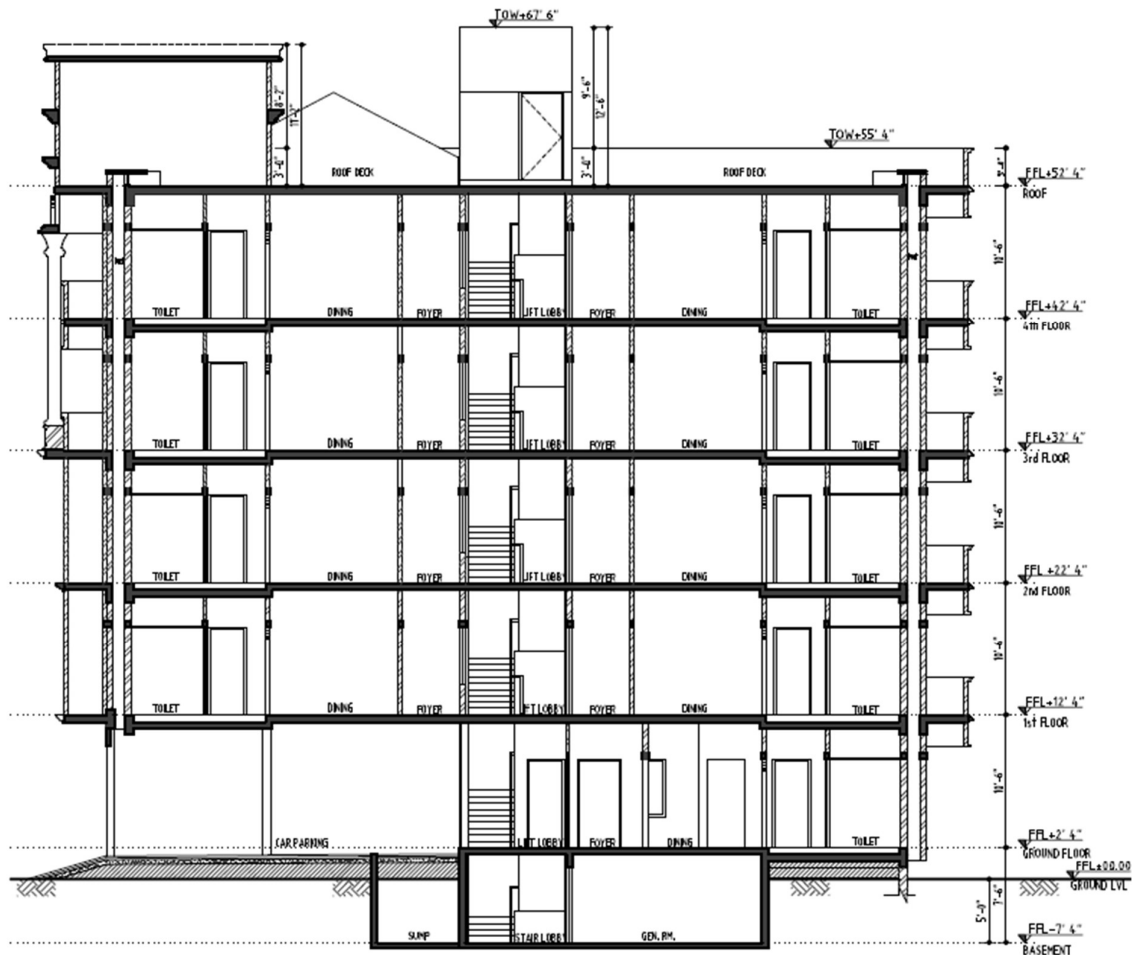

RAIN WATER HARVESTING SYSTEM

- Rain water harvesting and conservation, is the activity of direct collection of rain water. The conservation of rain water so collected can be stored for direct use or can be re charged into ground water.
- The main goal is to minimize flow of rain water through drains to the rivers without making any use of the same.
- It is known fact that the ground water level is depleting and going down and down in the last decades.
- Thus rain water harvesting and conservation aims at optimum utilization of the natural resources.
- Its primary source of water in the hydrological cycle.
- The rivers, lakes and ground water are the secondary sources of water

- In present times, in absence of rain water harvesting and conservation, we depend entirely on such secondary sources of water and in the process its forgotten that rain is the ultimate sources that feeds these resources.

GENERAL TERMS

AQUIFER

(also called ground water aquifer) any underground formation of soil or rock which can yield water.

ARTIFICIAL RECHARGE:

Any man made scheme or facility that adds water to an aquifer is artificial recharge system

RUNOFF:

Runoff is the term applied to the water that flows away from a surface after falling on the surface in the form of rain

RECHARGE:

The process of surface water (from rain or reservoirs) joining the ground water aquifer

“ Rain water Harvesting & Conservation means to understand the value of rain and to make optimum use of rain water at the place where it falls..”

FACTORS

The following are the reasons for ground water depletion

- Increasing demand
- With drawing more than recharge
- Reducing of recharge area due to buildings, paved paths and roads
- Diminishing surface water bodies
- Uncertain rainfall

ARTIFICIAL RECHARGE

Artificial recharge to ground water is a process by which the ground water reservoir is augmented at a rate of exceeding that obtained under natural conditions of replenishment.

ARTIFICIAL RECHARGE STRUCTURES FOR SURFACE RUN OFF

Ditch and furrow method

Lateral ditch pattern

- Large scale refers like town , cities or neighbourhood

Percolation tanks (PT)

- Individual residence scale of harvesting options
- These are the most prevalent structures in India as a measure to recharge the ground water reservoir both in alluvial as well as hard rock formations.
- The aquifer to be recharged should have sufficient thickness of permeable zone to accommodate the recharge
- The residents of multi storied complexes can safely utilize rainwater for their domestic requirements by way of filtering it & collecting into sumps and recharging the bore wells.

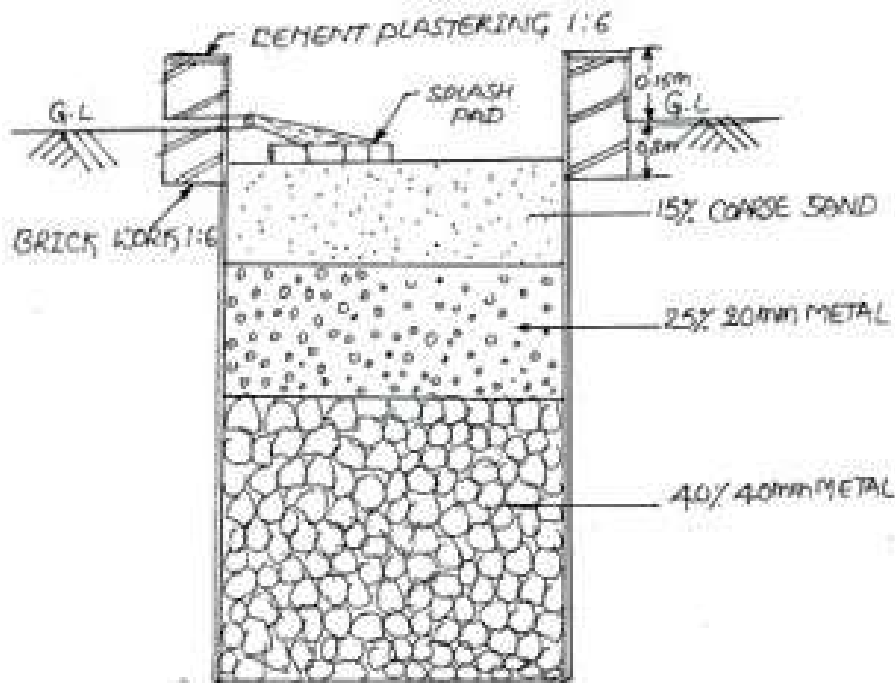

DIFFERENT OPTIONS OR TYPES OF PERCOLATION TANKS (PT)

- RECHARGE THROUGH ABANDONED DUG WELL
- RECHARGE THROUGH HAND PUMP
- RECHARGE PIT
- RECHARGE THROUGH TRENCH
- GRAVITY HEAD RECHARGE TUBE WELL
- RECHARGE SHAFT

BASIC COMPONENTS FOR RAIN WATER HARVESTING SYSTEM

CATCHMENT AREA/ROOF:

Surface upon which rain falls

GUTTERS AND DOWNSPOUTS:

transport channels *from* catchment surface to storage

LEAF SCREENS AND ROOF WASHERS:

Systems that remove contamination and debris.

CISTERNS OR STORAGE TANKS:

where collected Rain Water is stored

CONVEYING:

the delivery system for treated Rain Water, either by gravity or pump

WATER TREATMENT:

filters and equipment and additives to settle, filter and disinfect.

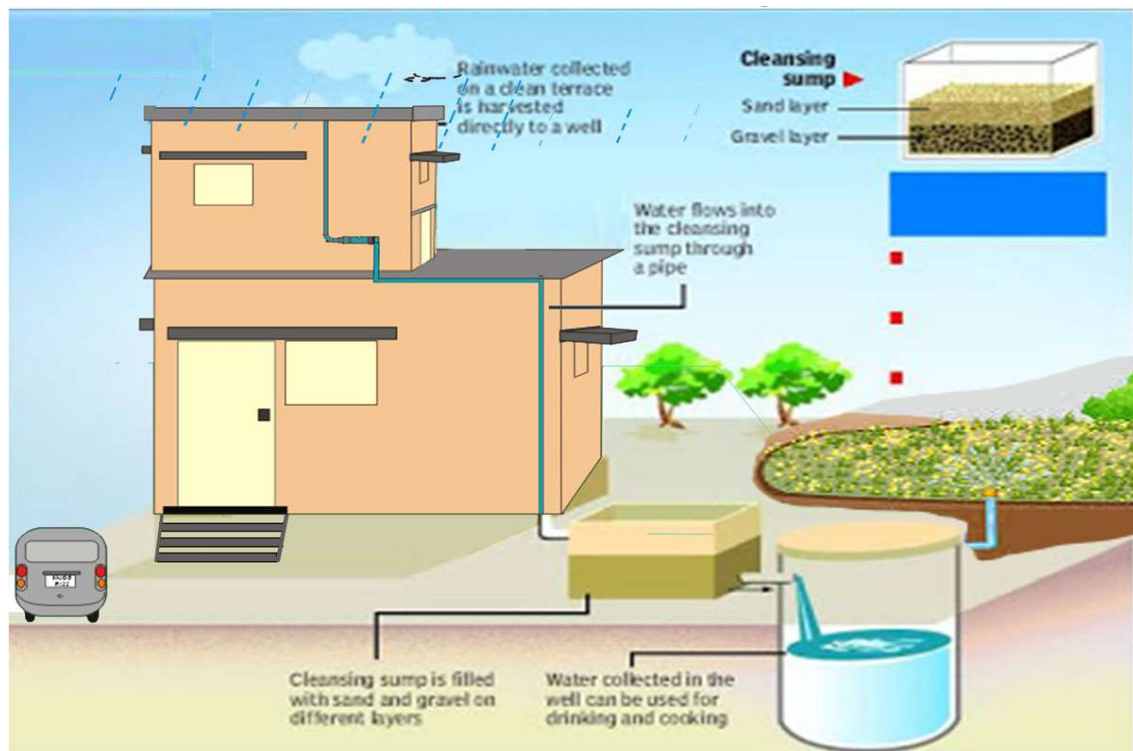

AVERAGE ANNUAL RAINFALL OF THE STATES OF INDIA

City	Avg. Rainfall/year
Tamil Nadu	- 998 mm
Maharashtra	- 3100 mm

Kerala - 3055 mm

ROOF CATCHMENT

Tiles - 0.8 - 0.9

Corrugated metal sheets - 0.7 - 0.9

GROUND SURFACE COVERING

0.5 - 0.75 as coefficient factor

Basic data required to calculate the amount of rain water harvesting system required for small residence

- Avg annual rainfall
- Size of catchment
- Drinking water requirements

Suppose the system has to be designed for meeting drinking water requirement of a 5 member family living in a building with a roof top area of 100 Sqm. Avg. annual rain fall is 600 mm. Daily drinking & cooking water requirement per person is 10 litres We shall first calculate the maximum amount of rain fall that can be harvested from roof top.

Area of Roof top	=	100 Sqm
Average annual rain fall	=	600 mm
Runoff co-efficient for tiles surface (typical case)	=	0.85
Co-efficient for evaporation, spillage and first flush etc. annual water harvesting potential from	=	0.80

100 Sqm roof top

= (Area of roof top) x (Annual rain falls in metre) x (Run off coefficient) x (Constant co-efficient)

$$= 100 \times .60 \times .85 \times 0.80 = 40.8 \text{ cum} = 40,800 \text{ litres}$$

The tank capacity has to be designed for dry period i.e. the period between two consecutive rainy season. With monsoon extending over 4 months the dry season is of 245 days has been considered.

Drinking water requirement for family for dry season $245 \times 5 \times 10 = 12,250$ litres

As a safety factor, the tank should be built 20% larger than required i.e. 14700 litres = (1.2 x 12250)

This tank can meet the basic drinking & cooking water requirement of a 5 member family for the dry period.



SATHYABAMA

INSTITUTE OF SCIENCE AND TECHNOLOGY
(DEEMED TO BE UNIVERSITY)

Accredited "A" Grade by NAAC | 12B Status by UGC | Approved by AICTE

www.sathyabama.ac.in

SCHOOL OF BUILDING AND ENVIRONMENT

DEPARTMENT OF ARCHITECTURE

UNIT - II

PLUMBING SYSTEM

INTRODUCTION

The system constitutes the following:

The water supply and water distribution system. Carries water from the water source, street main or a pump to the building and to various points in the building at which water is used.

The plumbing fixtures. The receptacles that receive the supplied water and allow the occupants of the building to use the water.

The drainage system. The piping network within the building which conveys from the plumbing fixtures all wastes and fecal matter (sanitary drainage) as well as rainwater (storm drainage) to a point of disposal or a treatment facility.

House Drainage

- The **W.C, Bathrooms, Sinks, Wash basins** are important components of a house. The occupants of the house make use of the above components and as a result of that there is a formation of waste water.
- The Waste water from W.C, bathrooms, sinks and wash basins is to be properly **disposed in to the municipal sewers.**
- It is therefore necessary to **construct a system of conveyance of wastewater** from W.C, bathrooms, kitchens and washbasins and disposal to the municipal sewer. This system is known as **house drainage system**

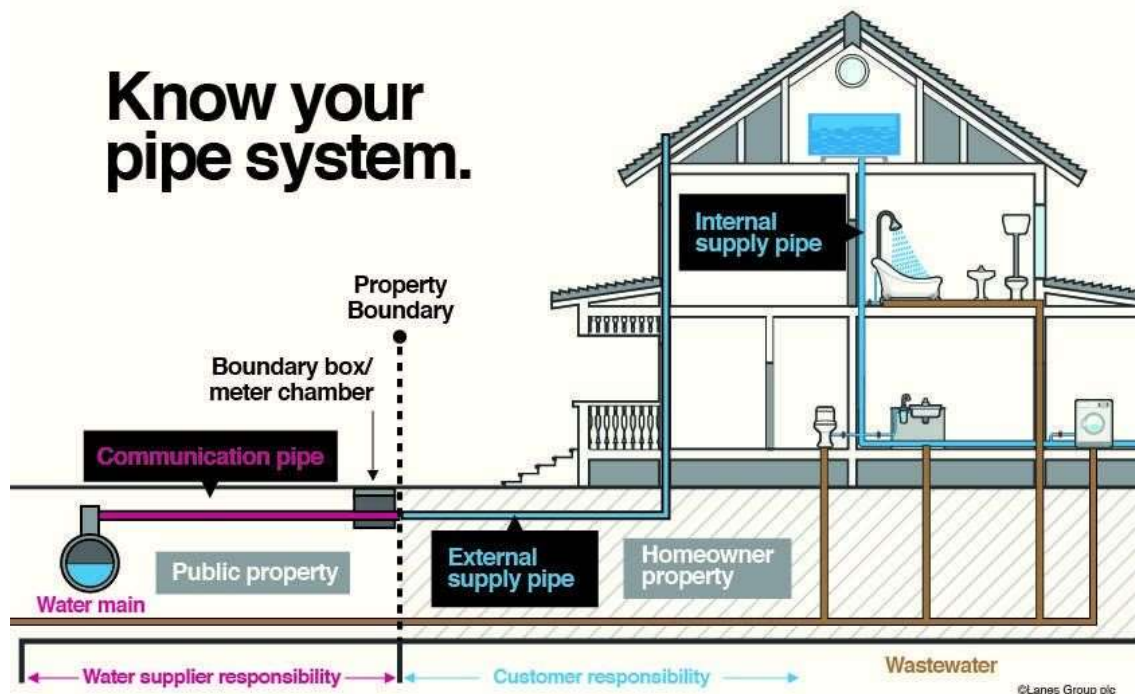

- Wastewater** Water when used for different purpose like domestic commercial, industrial etc., receives impurities and become wastewater. Thus wastewater is used water and it has **physical, chemical, and biological** Impurities in it. **wastewater is a general term.**
- Sewage** The waste water coming from W.C. and containing human excreta is known as sewage.
- Sullage** The Wastewater coming from bathrooms and kitchens which does not contain fecal matter is known as sullage.
- Plumbing System** It is entire system of pipe line for providing water supply to the building or it is a system of pipes for disposal of wastewater from the building.
- Sewer** A pipe carrying sewage/ wastewater is called sewer.
- Soil Pipe** It is pipe carrying sewage from W.C.
- Waste Pipe** It is a pipe carrying sullage from bathrooms, kitchens, sinks, wash basins, etc.
- Sewerage System** A system of sewers of different types and sizes in a town collecting wastewater from the town and carrying it to the wastewater treatment plant.
- Manhole** These are RCC/ Masonry chambers constructed at suitable intervals along sewer lines.
- Traps** Traps are defined as fittings at the end of soil pipes of waste pipes to prevent foul gases coming out of the soil pipe/ waste pipe.

Principles House Drainage

- House Drainage should be **preferable laid by side of the building** to facilitate easy repair and better maintenance.
- House sewer joints should be **leak proof** because leakage if any shall create an odour problem and leaked wastewater shall infiltrate in the ground and shall reduce **bearing capacity of soil** below foundation, which is not desirable.
- The sewage or sullage should **flow under the force of gravity**.
- The house sewer should **always be straight**.
- The entire system should be **well ventilated** from start to the end.
- The house sewer should be connected to the manhole such that the invert level is sufficiently higher to avoid back flow of sewage in house sewer.

- Where ever there is change in direction of sewer line in the premises, provide **inspection chamber at the junction.**
- **Rain water** from roofs or open courtyards **should not be** allowed to flow through the **house sewers.**
- **Siponage action** can never be permitted and therefore adequate **ventilation systems** should be installed.
- Sewer drains should be laid at a slope to achieve **self cleansing velocity of 0.6 -0.75 m/sec.**
- Sewer pipes should be at **least 900mm below the road and minimum 600 mm below the fields and gardens.**
- It should not be laid near foundation of buildings or near large trees.

SYSTEMS OF PLUMBING

- There are four systems adopted in plumbing of drainage work in a building
- Single stack system
- One pipe system
- One pipe system partially ventilated
- Two pipe system

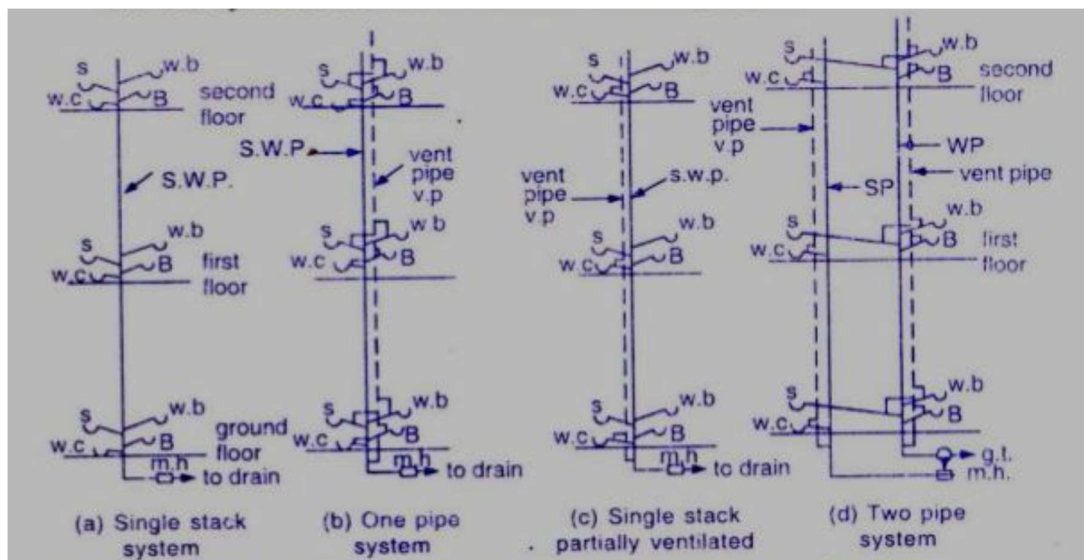

SINGLE STACK SYSTEM

This is a simplified one-pipe system without ventilation pipe work. The trap of water closet, sinks, basins, is directly connected to single stack.

The pipe, in addition, also acts as a vent pipe. The single stack system is economical

Single stack system has been found satisfactory in actual working if there is close grouping of sanitary appliances and short branches discharge soil and waste into the main stack in the direction of flow, there by minimizing the danger of loss of water seal of traps by induced siphonage.

The vertical distance between the waste water branch and we branch connection should be separated by minimum 200 mm when soil pipe is above waste water branch.

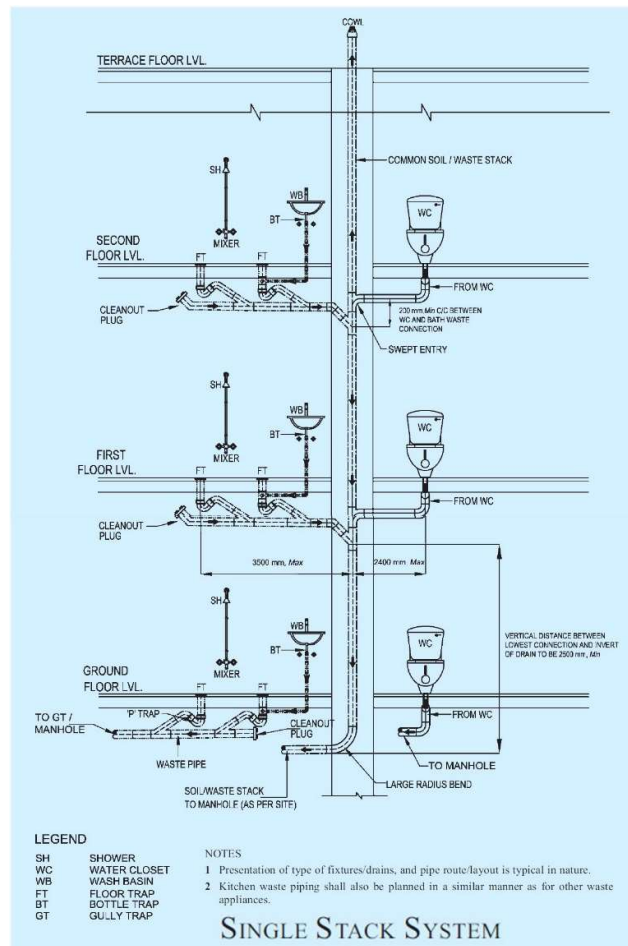

ONE PIPE SYSTEM PARTIALLY VENTILATED

In this, a single soil waste pipe conveys both soil and waste directly to the building drain.

A separate vent pipe is provided. Hence, it is more effective than the single stack system.

The vent pip provides ventilation to water seal of all the traps of Water Closets.

The term one pipe system is a misnomer as there are actually two stacks, one soil-cum-waste pipe, and the other vent stack.

This system is suitable for buildings when the toilet layout and the shafts are repetitive as it requires less space and is economical.

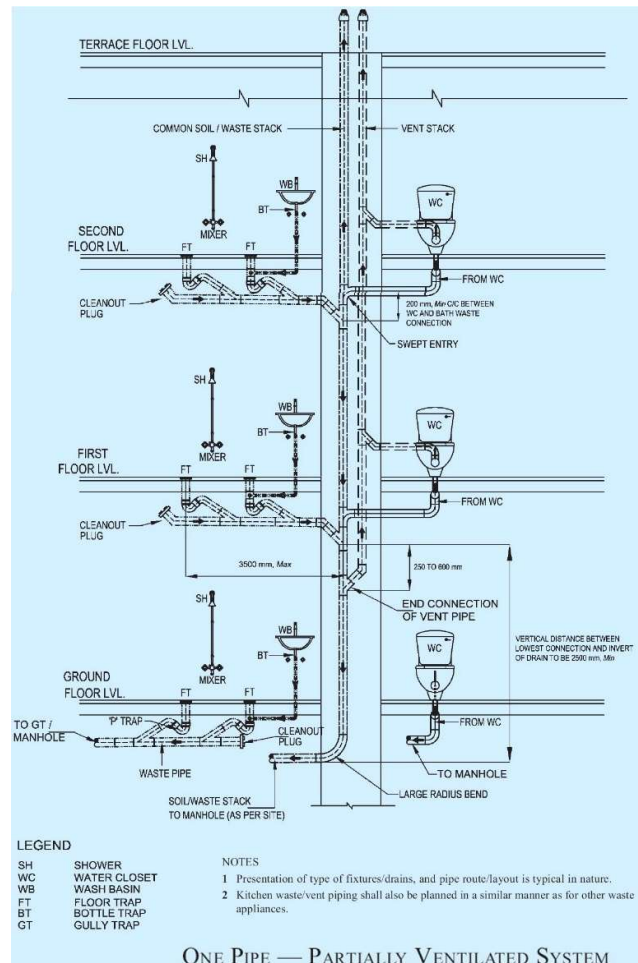

ONE PIPE SYSTEM FULLY VENTILATED

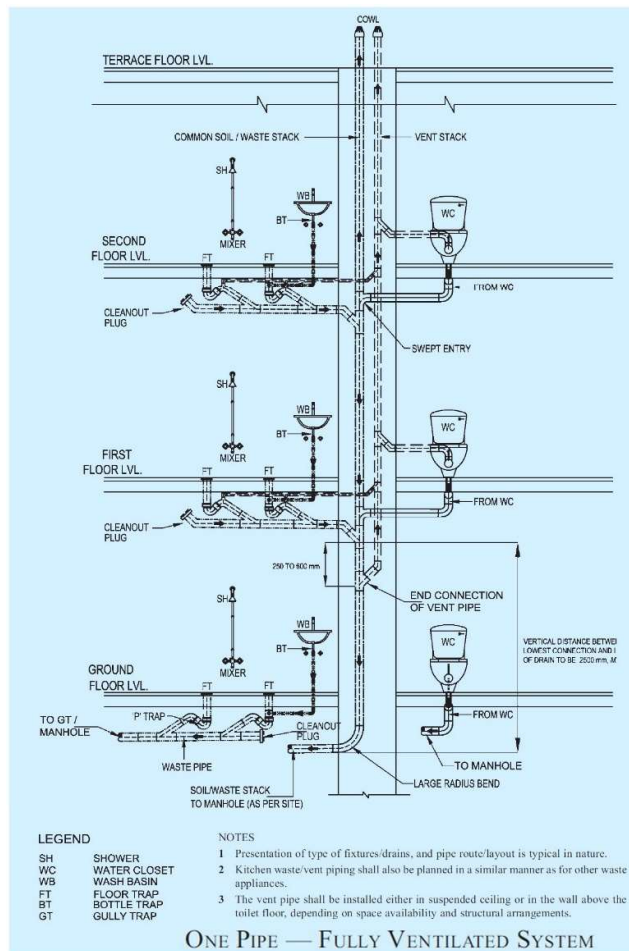

TWO PIPE SYSTEM WITH COMMON VENT PIPE

In this system of plumbing, the soil and the waste pipes are distinct and separate as shown in figure. The soil pipes are connected to the building sewer direct.

Waste pipes are connected to the building sewer through a trapped gully. The gully trap forms a barrier to the passage of foul air from the sewer into waste pipe.

All traps of soil appliances are completely ventilated through a separate ventilating pipe. Likewise traps of all waste appliances are completely ventilated through a separate ventilating pipe.

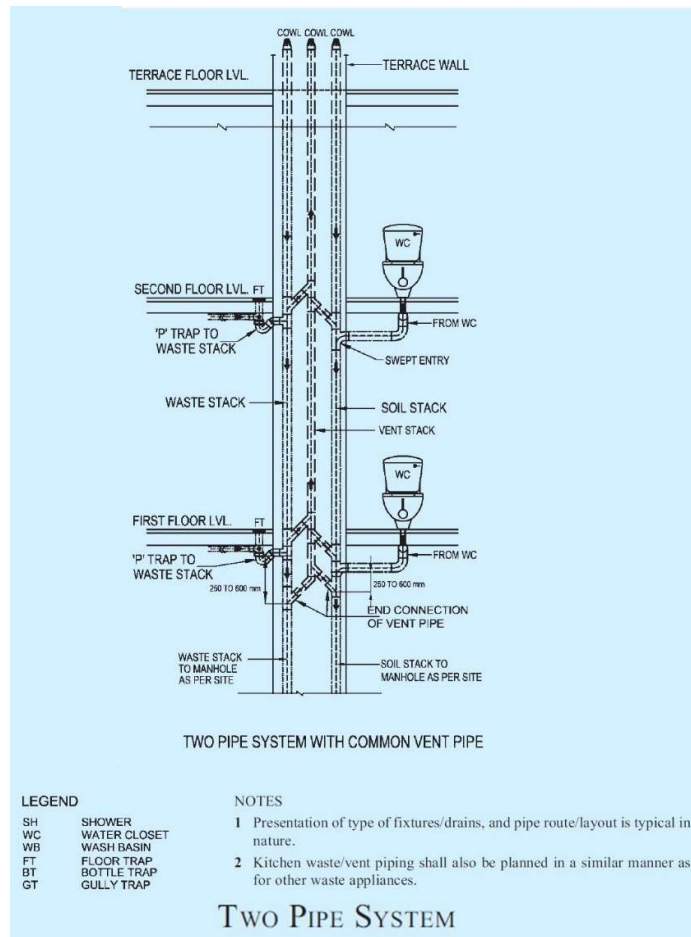

TWO PIPE SYSTEM WITH INDEPENDENT VENT PIPE

Thus this system of plumbing contains one soil pipe, one waste pipe and two (or one) ventilating pipes.

The two-pipe system is age-old and safe system, especially advantageous where the sullage (waste water) from waste appliances can be dealt with separately for use in gardening or other such purposes.

The two pipe system is proper system to adopt where fitments are scattered with water closet, baths and basins widely separated.

Due to unsightly and uneconomic web of pipes, this system is not much favored today.

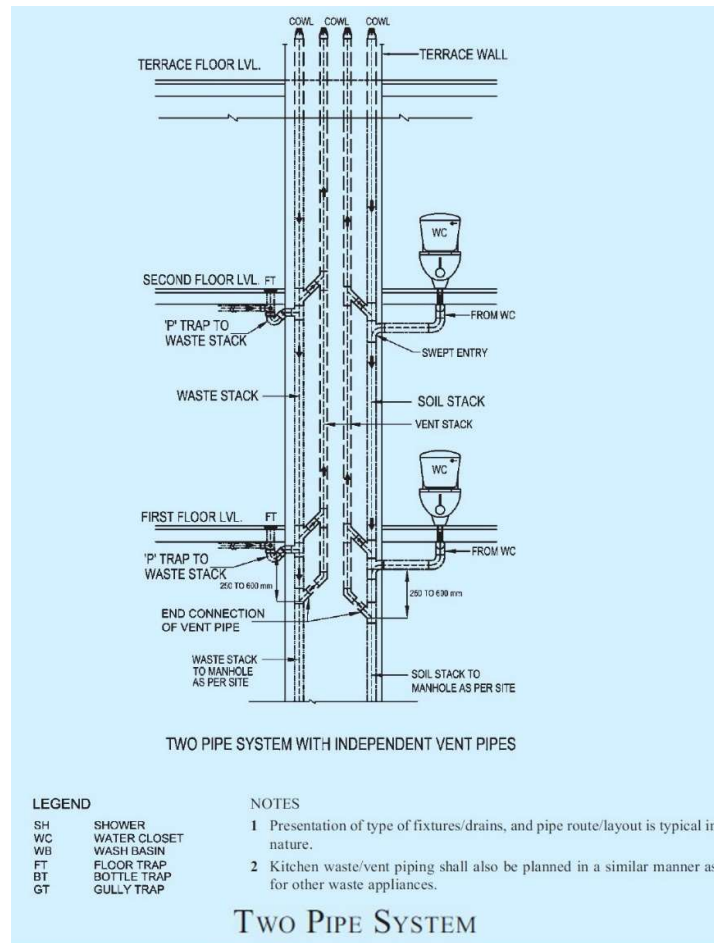

TRAP

A trap is a fitting provided in a drainage system to prevent entry of foul air or gases from the sewer or drain into the building. The barrier to the passage of foul air is provided by the water seal in the trap.

A trap is merely a double bend or loop in the sanitary fitting, the depth of water seal being the distance of the first bend and the bottom of the second.

The deeper the seal the more efficient is the trap.

The depth of the water seal varies from 40 to 75 mm.

The trap should always be fitted close to the waste or soil fitting unless the trap is an integral part of the fitting as in case of European WC (siphon type).

TYPES OF TRAPS

Depending upon the shapes the traps are classified as:

- **P-Trap**
- **Q-Trap**
- **S-Trap**

Above three types of traps are shown in the following figure

DEPENDING ON THE USE AND LOCATION

- Floor trap (Nahani trap)
- Gulley trap
- Intercepting trap
- Silt trap
- Grease and oil traps

Floor Trap (Nahani Trap)

Floor traps are provided in floors to collect waste water from kitchen sinks, bathroom floors, washing floors, etc. A floor trap forms the starting point of waste flow.

The trap is made of cast iron or PVC, provided with a removable grating at top so as to prevent the entry of solid matter. The depth of water seal of floor trap should not be less than 40 mm.

Gulley Trap

The gulley trap is usually situated near the external face of the wall. It disconnects the waste water flowing from kitchen, bathroom, wash-basin and floors from the main drainage system

This is a deep seal trap forming a barrier for preventing the foul gases from house drain to the inside of the building.

It is made of cast iron or glazed stoneware. Grating is provided on top to retain all solid matter. It is fitted in a small masonry enclosure to meet the requirements of invert levels of waste pipes discharging into the gulley trap.

The water seal of about 60 to 70 mm is provided in the gulley trap. Gulley trap is provided in the waste pipe only. The maximum distance between the gulley trap and the first manhole should be 6 m.

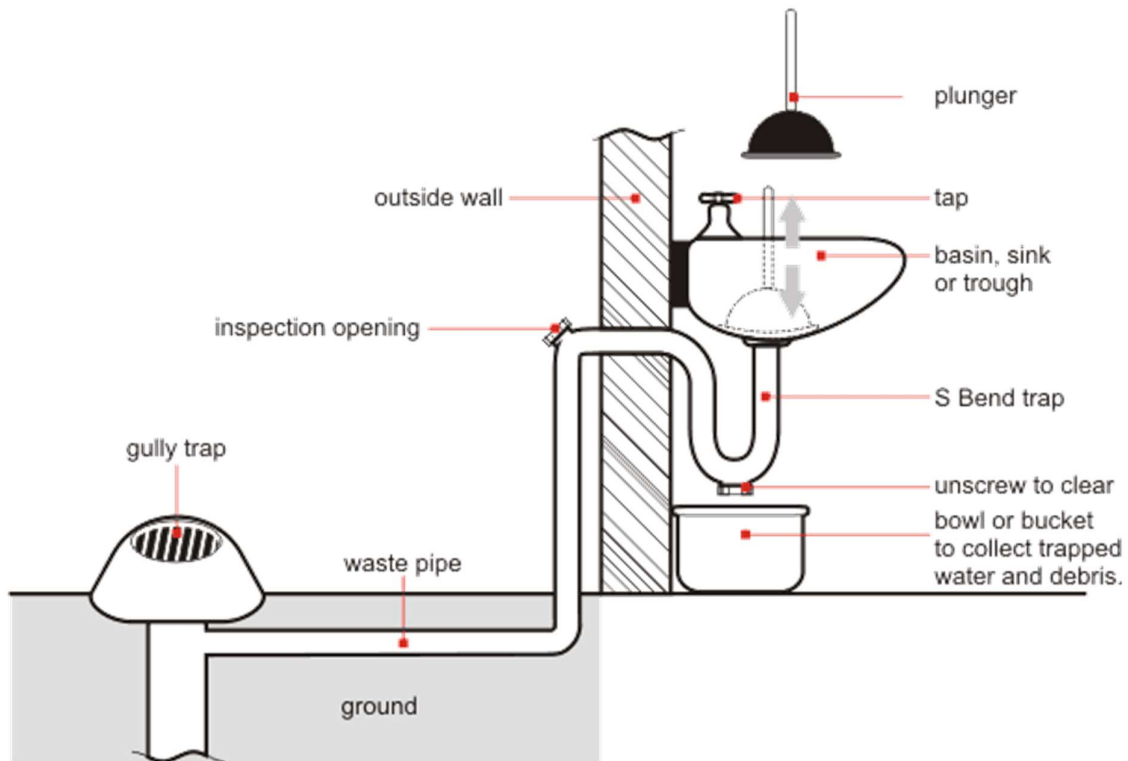

INTERCEPTING TRAP

This trap is provided at the last manhole, i.e. at the junction of house drain (inspection chamber) and the public sewer so as to prevent the entry of foul air from public sewers to the house drain.

The trap is made of glazed stoneware with an inspection arm for the purpose of cleaning or inspection. The inspection arm is kept closed by a lid or plug.

The water seal is deeper than that of normal traps (not less than 100 mm).

Though the use of intercepting trap is not essential; the provision of this trap is sometimes made compulsory by the local authority and thus it is a matter of policy of local authority.

GREASE AND OIL TRAPS

These are chambers provided on the sewer line to exclude grease and oil from sewage before it enters the sewer line. These traps work on the principle that grease or oil being light in weight float on the surface of sewage. Thus, the inlet pipe is near the top of the chamber and the outlet pipe is near the bottom.

The grease and oil traps are located near the sources contributing grease and oil to sewage like automobile repair workshops, grease and oil producing industries, garages, hotel kitchens, etc. If grease or oil is not removed, it sticks to the sides of sewer, reducing its capacity. Moreover, presence of grease or oil in sewer adversely affects the biochemical reactions during sewage treatment.

PLUMBING FIXTURES

TAPS

Taps fall into three main design categories, wall mounted taps are known as Bib Taps, those mounted directly onto the sink, basin or bath are called Pillar Taps, and thirdly there are Mixer Taps, which have a hot and cold valve linked to a single spout.

Traditionally, most taps used the Pillar design. These work by having a Rubber or Nylon (or leather) washer on a threaded pillar/spindle inside the body of the tap. When the tap is closed, the washer would sit on top of the water supply pipe. As the tap is unscrewed the whole pillar unscrews and rises with the washer, allowing the water to pass into the spout.



TYPES OF TAPS

- BIB TAP
- PILLAR TAP
- CERAMIC DISC TAP
- SELF – CLOSING TAP
- BASIN PILLAR TAP

BIB TAP: It is a draw-off tap with horizontal inlet and free outlet. A bib tap is closed by means of disc carrying a renewable non-metallic washer which shuts against the water pressure on a seating at right angles to the axis of the threaded spindle which operates it.

The bib taps are provided with threads on the external side and have to be connected to a socket at the pipe out let.

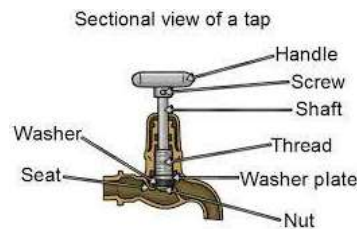

STOP VALVE

Stop Value is almost identical in function, except that it does not have a spout but it is inserted in a pipe line for controlling or stopping water flow. The stop valves are available in nominal sizes of 15,20,25,32,40 and 50 mm.

PILLAR TAP

The traditional spindle design is commonly used on lower quality, cheaper tap designs. The tap has a spindle through the centre, with the valve seat connected via a screw thread. A standard tap washer (either 15 mm or 20mm) is fixed to the end of the valve seat. As the handle is turned the spindle rotates and the screw thread moves the valve seat up and down to regulate the flow of water

These taps are very commonly used for all purposes but have following shortcomings,

- Difficult to operate - handle has to be turned many times from off to full on.
- Higher maintenance - washers will require replacing regularly
- Less choice of style - cannot be used with modern lever designs.

CERAMIC DISC TAPS

This technology is commonly used on more expensive taps, as they perform better and last longer. When the handle is turned, two ceramic discs are parted opening the valve and allowing the water to flow.

The one disc is in a fixed position and the other turns up to 90% with the handle. These two discs are aligned in the open position. This type is used in most superior taps and mixer valves, where the operation is by small turn or lift of the knob.

SELF-CLOSING TAP

A self-closing tap is a draw-off tap which remains in the open position so long as a lever handle is kept pressed up, down or sideways, or a pushbutton is kept pressed in, and closes by itself or when the button or the lever handle is released; the self-closing taps may incorporate a device which closes the tap even without the release of the button or the handle after a fixed quantity is discharged. These types of taps prevents wastage of water and are normally fixed at location where heavy public traffic is expected all the time

NOMINAL SIZE: - Self-closing taps shall be of the following nominal sizes. Nominal size refers to the nominal bore of the inlet connection. (15mm& 18mm)

The force required for operating the self-closing tap for its full opening should not exceed 70N.

MIXER VALVES

Hot and cold water is carried in different pipes and mixed in a mixer valve at the point of discharge, through a common spout.

MATERIAL USED FOR THE TAP

All sanitary appliances and their components shall be durable, impervious, and corrosion resistant and have smooth surface which may be easily cleaned. They shall conform to relevant Indian Standard where they exist, otherwise they shall be of the best quality and workmanship which shall be approved by a competent authority. Taps can be made from a variety of materials of varying quality and cost. A general rule of thumb is that the heavier the tap the better the quality of materials used. Some other materials along with suitable coatings are also used for manufacturing the taps apart from plastic and brass given below.

PLASTIC TAP

Plastic taps are very cheap and generally low quality. They are very light and are available in a range of colors. 15 mm and 20 mm are the normal sizes of plastic taps available. Now a days superior quality plastic taps are also manufactured with GFN (Glass filled Nylon). They are to be manufactured as per IS:9763 and are suitable for use up to 1MPa pressure and water temperatures 90°C. However the recommended temperature for use is 65°C.

BRASS TRAP

Standard brass is commonly used to manufacture the bodies of mid- priced, medium quality taps.

Many tap components (such as handles) can be made from plastic. These are cheaper than using brass, and whilst the quality is often very good, brass offers a better finish and longevity.

WASH BASINS & SINKS

A Wash basin is made up of vitreous china and is available in wide range of colors, patterns and sizes. Washbasins are of one piece construction including a combined overflow and soap holder.

An overflow slot, if provided, shall have a horizontal dimension not larger than 64 mm and an area not less than 500 mm². A round overflow of the same area can be an alternate design.

The soap recess(es) shall have adequate provision for draining into the bowl. All internal angles are designed so as to facilitate cleaning.

The sinks are also the similar construction as wash basins, except that the size of sinks is much larger and the bottom surface is level/flat compared to rounded shape for wash basins

CONSTRUCTION

Wash basins are provided with five, three, two or single tap hole, round in shape and symmetrical about the centre line of the basin and either fully punched or semi-punched. The tap holes shall be suitable for fixing pillar taps conforming to IS 1795:1982 or to IS 893:1993. The level of the top of the platform which accommodates the taps is not to be below the spillover level of the basin irrespective of the overflow arrangement.

Each basin shall have a circular waste hole. The waste hole shall accommodate a waste fitting having a flange diameter of 64 mm (IS 2963:1979).

Each wash basin has a rim on all sides, except sides in contact with the wall and has a skirting at the back. The entire flat surface should have sloped inside towards the bowl.

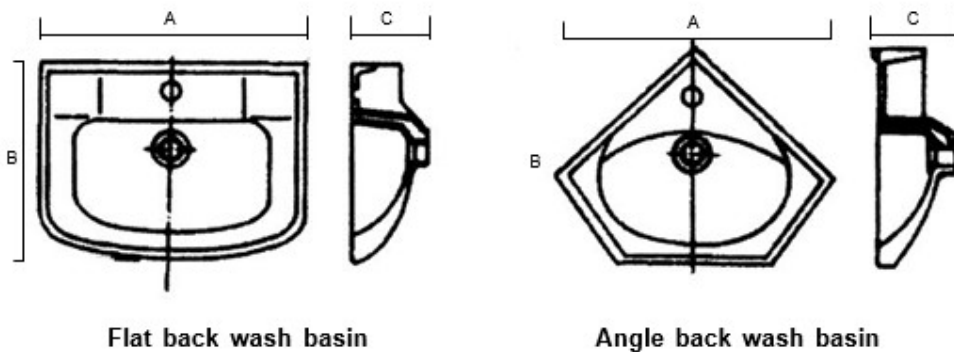

WASHBASIN TYPES

Wash basins can be broadly classified as :-

- 1) **Wall hung** or 2) **Counter fitted.**

Wall hung wash basins are further classified as

- **Flat back**
- **Angle back**
- **Full pedestal**

Counter fitted wash basin are further classified as

- **Under the counter**
- **Over the counter**

Counter top

Layout of Toilet - Section

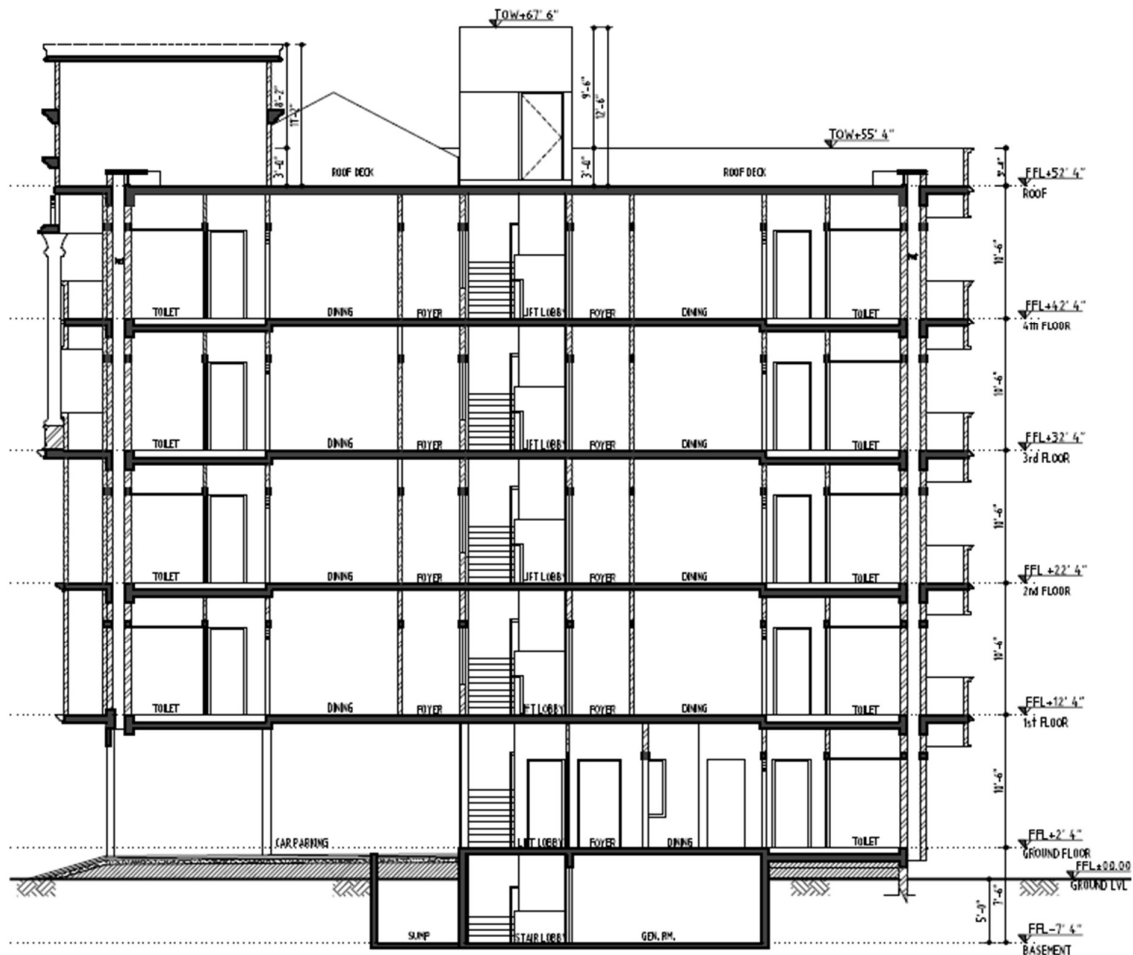

RAIN WATER HARVESTING SYSTEM

- Rain water harvesting and conservation , is the activity of direct collection of rain water. The conservation of rain water so collected can be stored for direct use or can be re changed into ground water.
- The main goal is to minimize flow of rain water through drains to the rivers without making any use of the same.
- It is known fact that the ground water level is depleting and going down and down in the last decades.
- Thus rain water harvesting and conservation aims at optimum utilization of the natural resources.
- Its primary source of water in the hydrological cycle.
- The rivers, lakes and ground water are the secondary sources of water

- In present times, in absence of rain water harvesting and conservation, we depend entirely on such secondary sources of water and in the process its forgotten that rain is the ultimate sources that feeds these resources.

GENERAL TERMS

AQUIFER

(also called ground water aquifer) any underground formation of soil or rock which can yield water.

ARTIFICIAL RECHARGE:

Any man made scheme or facility that adds water to an aquifer is artificial recharge system

RUNOFF:

Runoff is the term applied to the water that flows away from a surface after falling on the surface in the form of rain

RECHARGE:

The process of surface water (from rain or reservoirs) joining the ground water aquifer

“ Rain water Harvesting & Conservation means to understand the value of rain and to make optimum use of rain water at the place where it falls..”

FACTORS

The following are the reasons for ground water depletion

- Increasing demand
- With drawing more than recharge
- Reducing of recharge area due to buildings, paved paths and roads
- Diminishing surface water bodies
- Uncertain rainfall

ARTIFICIAL RECHARGE

Artificial recharge to ground water is a process by which the ground water reservoir is augmented at a rate of exceeding that obtained under natural conditions of replenishment.

ARTIFICIAL RECHARGE STRUCTURES FOR SURFACE RUN OFF

Ditch and furrow method

Lateral ditch pattern

- Large scale refers like town , cities or neighbourhood

Percolation tanks (PT)

- Individual residence scale of harvesting options
- These are the most prevalent structures in India as a measure to recharge the ground water reservoir both in alluvial as well as hard rock formations.
- The aquifer to be recharged should have sufficient thickness of permeable zone to accommodate the recharge
- The residents of multi storied complexes can safely utilize rainwater for their domestic requirements by way of filtering it & collecting into sumps and recharging the bore wells.

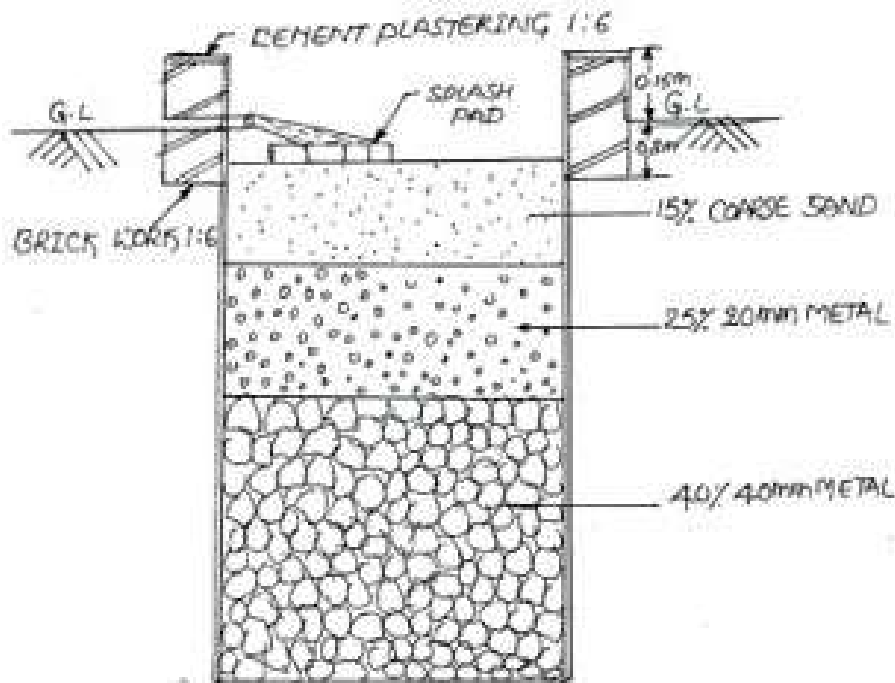

DIFFERENT OPTIONS OR TYPES OF PERCOLATION TANKS (PT)

- RECHARGE THROUGH ABANDONED DUG WELL
- RECHARGE THROUGH HAND PUMP
- RECHARGE PIT
- RECHARGE THROUGH TRENCH
- GRAVITY HEAD RECHARGE TUBE WELL
- RECHARGE SHAFT

BASIC COMPONENTS FOR RAIN WATER HARVESTING SYSTEM

CATCHMENT AREA/ROOF:

Surface upon which rain falls

GUTTERS AND DOWNSPOUTS:

transport channels *from* catchment surface to storage

LEAF SCREENS AND ROOF WASHERS:

Systems that remove contamination and debris.

CISTERNS OR STORAGE TANKS:

where collected Rain Water is stored

CONVEYING:

the delivery system for treated Rain Water, either by gravity or pump

WATER TREATMENT:

filters and equipment and additives to settle, filter and disinfect.

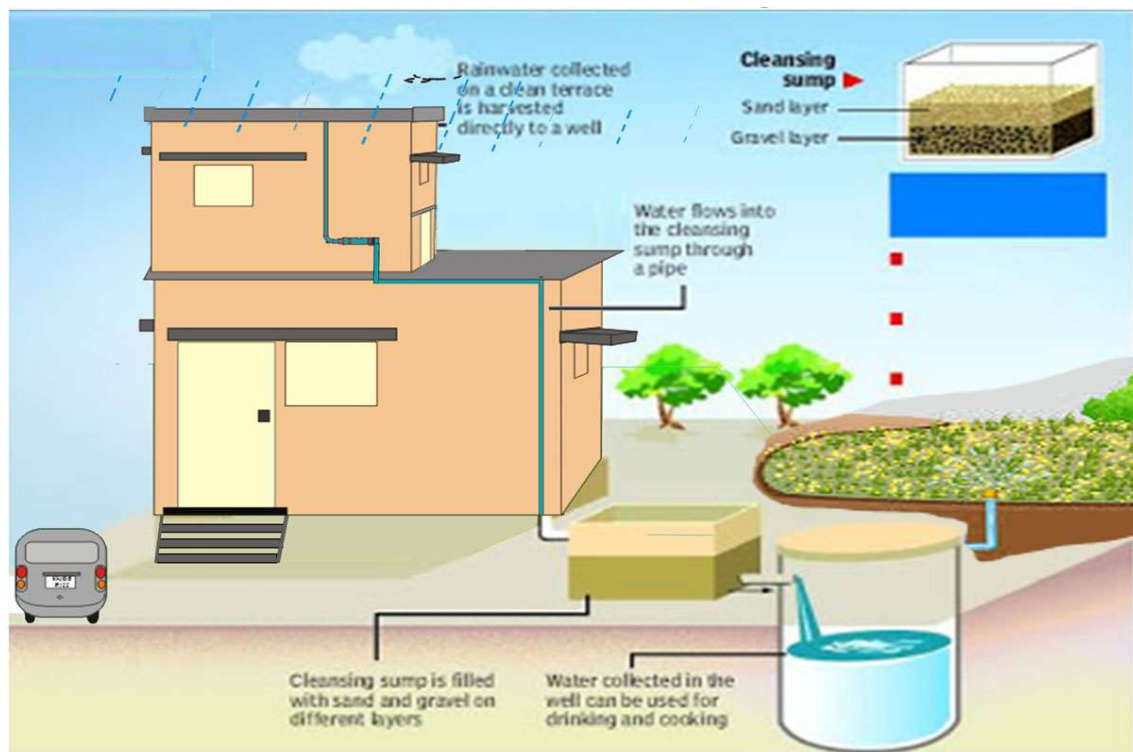

AVERAGE ANNUAL RAINFALL OF THE STATES OF INDIA

City	Avg. Rainfall/year
Tamil Nadu	- 998 mm
Maharashtra	- 3100 mm
Kerala	- 3055 mm

ROOF CATCHMENT

Tiles - 0.8 - 0.9

Corrugated metal sheets - 0.7 - 0.9

GROUND SURFACE COVERING

0.5 - 0.75 as coefficient factor

Basic data required to calculate the amount of rain water harvesting system required for small residence

- Avg annual rainfall
- Size of catchment
- Drinking water requirements

Suppose the system has to be designed for meeting drinking water requirement of a 5 member family living in a building with a roof top area of 100 Sqm. Avg. annual rain fall is 600 mm. Daily drinking & cooking water requirement per person is 10 litres. We shall first calculate the maximum amount of rain fall that can be harvested from roof top.

Area of Roof top	=	100 Sqm
Average annual rain fall	=	600 mm
Runoff co-efficient for tiles surface (typical case)	=	0.85
Co-efficient for evaporation, spillage and first flush etc.	=	0.80

100 Sqm roof top

= (Area of roof top) x (Annual rain falls in metre) x (Run off coefficient) x (Constant co-efficient)

$$= 100 \times .60 \times .85 \times 0.80 = 40.8 \text{ cum} = 40,800 \text{ litres}$$

The tank capacity has to be designed for dry period i.e. the period between two consecutive rainy season. With monsoon extending over 4 months the dry season is of 245 days has been considered.

Drinking water requirement for family for dry season $245 \times 5 \times 10 = 12,250$ litres

As a safety factor, the tank should be built 20% larger than required i.e. 14700 litres = (1.2×12250)

This tank can meet the basic drinking & cooking water requirement of a 5 member family for the dry period.

FLUSHING CISTERNS

Many years ago most water closets had their tanks/ flushing cisterns near the ceiling, 2 m. or more above the water closet. Now tanks either rest against the back of the water closet or are hung from the wall with their bottoms just a few cms. Above the closet or even resting on the W.C. Still another type has a flush valve on the flush pipe and no tank is provided, but it is not practical for most homes because, in many cases, the water volume is insufficient to make it operate properly.



SCHEMATIC OUTLINE OF FLUSHING CISTERNS

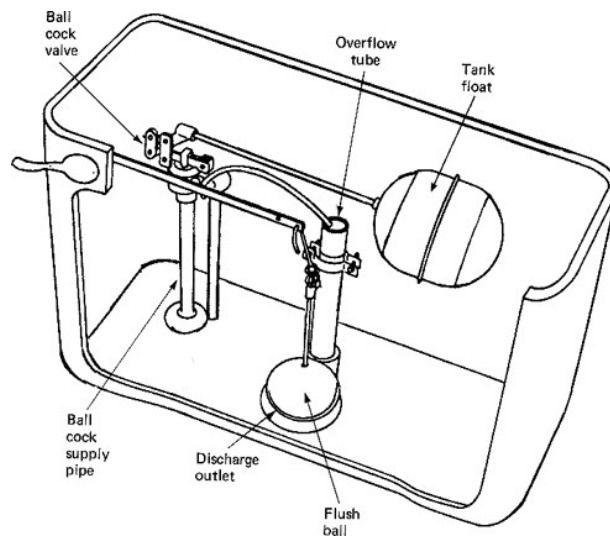

TYPES OF FLUSHING CISTERNS

- FLUSHING VALVES
- ATMOSPHERIC VACUUM BREAKER (AVB)
- BELL TYPE CISTERN
- FLAP FLUSH , PUSH BUTTON LAVATORY CISTERNS
- SIPHON FLUSHING CISTERN
- CONCEALED FLUSHING TANK

FLUSHING VALVES

Flushing without water cisterns is achieved using Flush valves. These flushing valves are being used in some public lavatories, with push type and self closing valves, to save on the water consumption.

However, this system can be adopted where continuous water supply is available.

In case these valves are directly connected to potable water supply and in the event of chocking of the soil pipe or the W.C. outlet, there is a danger of cross connection of potable water with the soiled

water due to back suction through the valve.

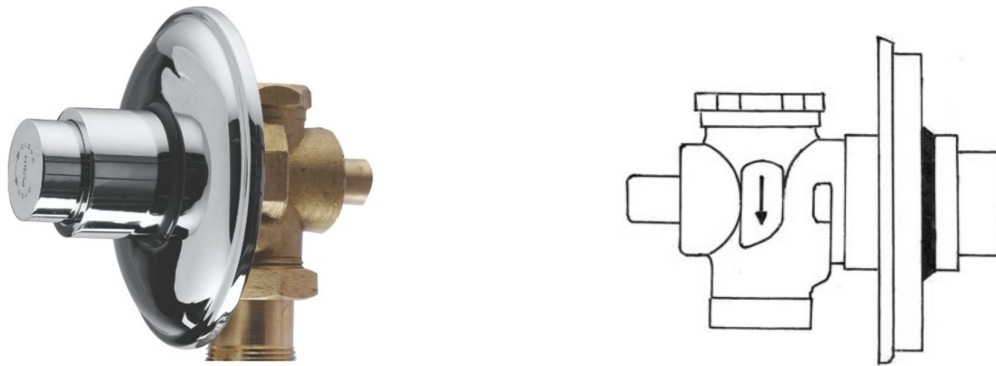

ATMOSPHERIC VACUUM BREAKER (AVB)

AVB is a backflow prevention device used in plumbing to prevent backflow of non-potable liquids into the drinking water system. If the pressure in the "**upstream side**" is reduced to atmospheric pressure or below, the pop- pet valve drops and allows air to enter the system, breaking the siphon.

The AVB should be installed at least 150mm above the highest use down stream.

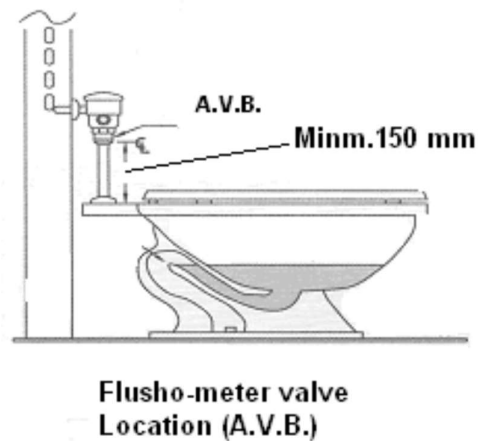

The AVB is for "**Low Hazard**" applications only and should not be used with continuous pressure on the device, as the poppet would likely stick and the AVB would no longer function properly. A shutoff valve should never be placed downstream of any AVB, as this would result in continuous pressure on the AVB. The AVB is not a testable device.



BELL TYPE CISTERN

The Burlington, or bell, style cistern is only suitable for high level cisterns and is now considered old fashion but can still be found in old houses.

These cisterns are normally made from cast iron and are easily recognized by the 'well' in the base into which the 'bell' sits. The flow-down pipe to the lavatory pan is positioned within the bell with the open top just above the normal cistern water level.

When the cistern chain is pulled, the lever at the top of the cistern lifts the bell drawing the water under the bell upwards into the top of the open flow-down pipe, once the water starts down the pipe, it starts a siphon effect drawing the rest of the water from the cistern until air is drawn under the bottom of the bell.



FLAP FLUSH , PUSH BUTTON LAVATORY CISTERNS

This flap flush valve directly controls the flow of water from the cistern. The down pipe to the lavatory pan is attached to the outlet under the flap and mounted at the bottom of the cistern.

This flap flush valve directly controls the flow of water from the cistern. The down pipe to the lavatory pan is attached to the outlet under the flap and mounted at the bottom

To operate a flap flush valve cistern, a button (normally fitted to the top of the cistern cover) is pushed to lift the valve by means of a chain or lever. With the flap opened, the water flows down the pipe to the lavatory pan.

Release of the button, allows the flap to close and the water, as it fills the cistern, seals the flap against its seat

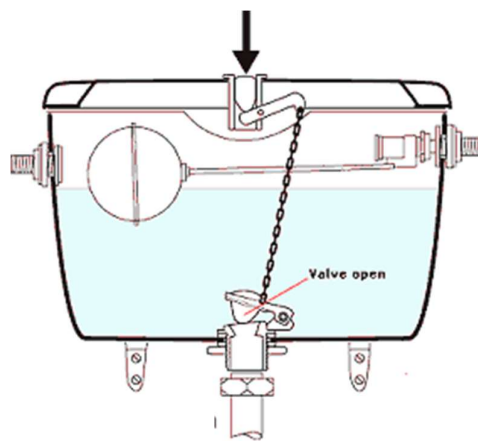

SIPHON FLUSHING CISTERN

Siphon flushing cistern has a ceramic or plastic siphon, as shown in above picture, next to the flush pipe. The lever is connected to the valve in the siphon, which is lifted up when the lever is moved up, and water enters the siphon by suction created by it. The whole cistern is flushed through the flush pipe into the we, washing off the soil in the pan

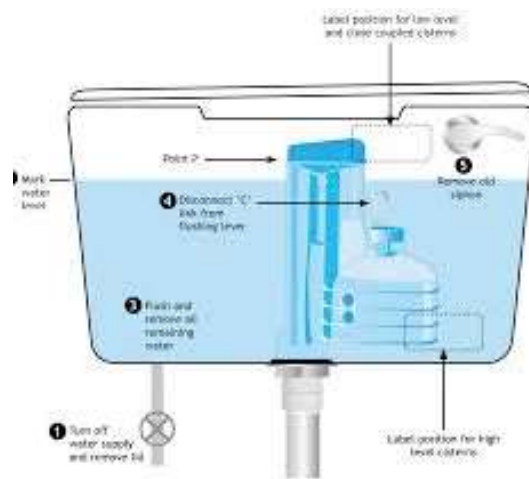

SUBSOIL DRAINAGE SYSTEMS

1. Subsoil drainage systems are provided to drain away subsurface water in order to increase the stability of the ground and footings of buildings by inducing a more stable moisture regime and reducing foundation movements due to the variations in the soil moisture content
2. mitigate surface water ponding and waterlogging of soils by lowering water tables
3. alleviate ground water pressures likely to cause dampness in below-ground internal parts of buildings or damage to foundations of buildings, other structures, or pavements and/or increase soil strength by reducing the moisture content.

SUBSOIL DRAINAGE SYSTEMS

Subsoil drainage is an important part of road construction.

Vehicular traffic on pavement with a saturated subbase results in rapid deterioration of the pavement.

Entrapped water that is subject to vehicular loadings creates large hydrostatic and hydrodynamic pressures within the subbase, reducing its ability to provide stable support for the pavement.

One important factor indicating a need for subsoil drainage

is the presence of a water table high enough to have an adverse effect on buildings and infrastructure within urban developments. Subsoil drainage is particularly important in hillside areas due to the potential to create land instability

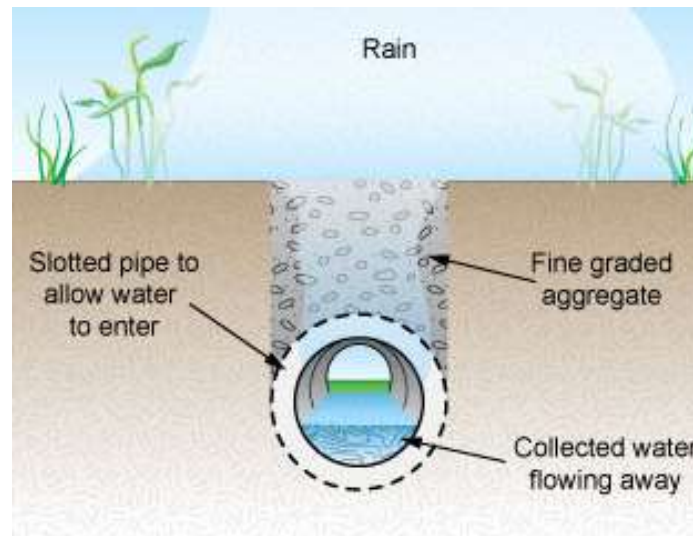

SUBSOIL DRAINAGE SYSTEMS – CROSS SECTION

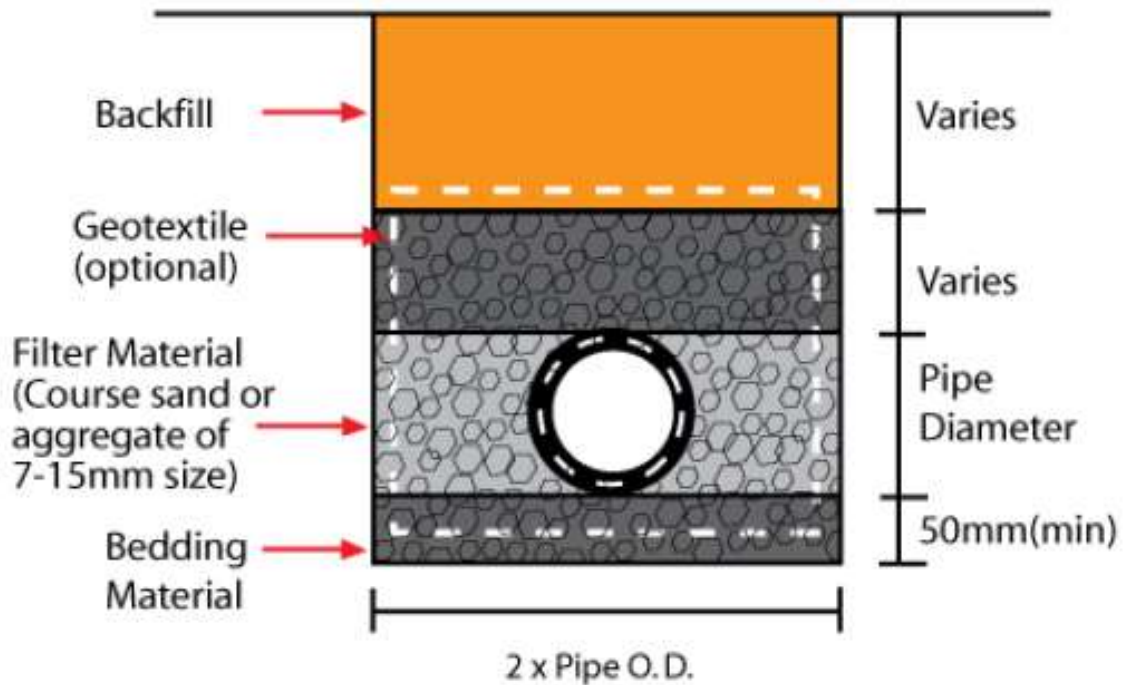

SUBSOIL DRAINAGE SYSTEMS – SCHEMATIC DETAILS OF LAYOUT PROCESS

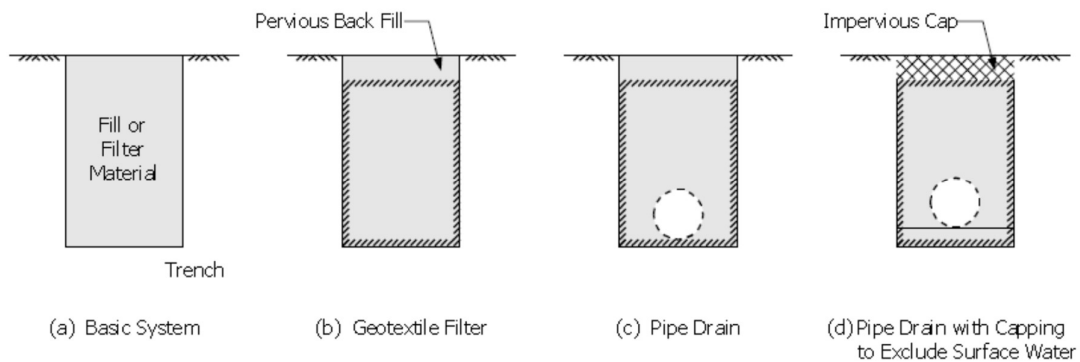

Basic system

which is a trench with fill or filter material (commonly sand or gravel). This simple arrangement is called a rubble drain or French drain

Geo textile filter

The addition of a geotextile lining to prevent external fine soil particles being washed into the filter material and clogging it.

Both this and the unlined rubble drain have only limited effectiveness due to their limited ability to convey water.

Pipe Drain

The addition of a pipe to promote more rapid drainage.

This is the most common type of subsoil drain.

The pipe is perforated to allow easy entry of water and can be rigid or flexible.

Pipe drain with capping to exclude surface water

It shows two further variations – an impervious cap for situations where the drain is intended to collect only subsurface flows, and bedding material for cases where the base of the excavation is unsuitable as a pipe support.

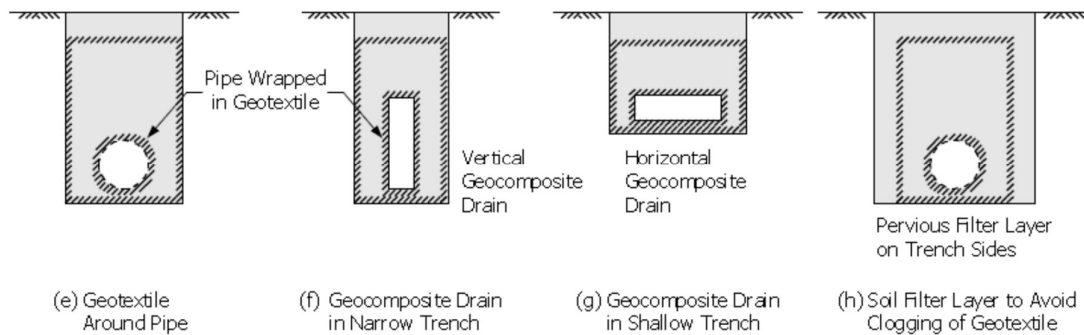

The pipe can be wrapped in geotextile to prevent piping and loss of filter material. Geocomposite drains of various configurations and manufacture can be provided. These are usually of plastic wrapped in geotextile and various proprietary systems are available. Shows an external layer of filter material provided around the geotextile encompassing the filter material. This might be used where there is a likelihood of fine particles or deposits, e.g. iron precipitates, clogging the geotextile.

LAYOUT OF DRAINAGE SYSTEM

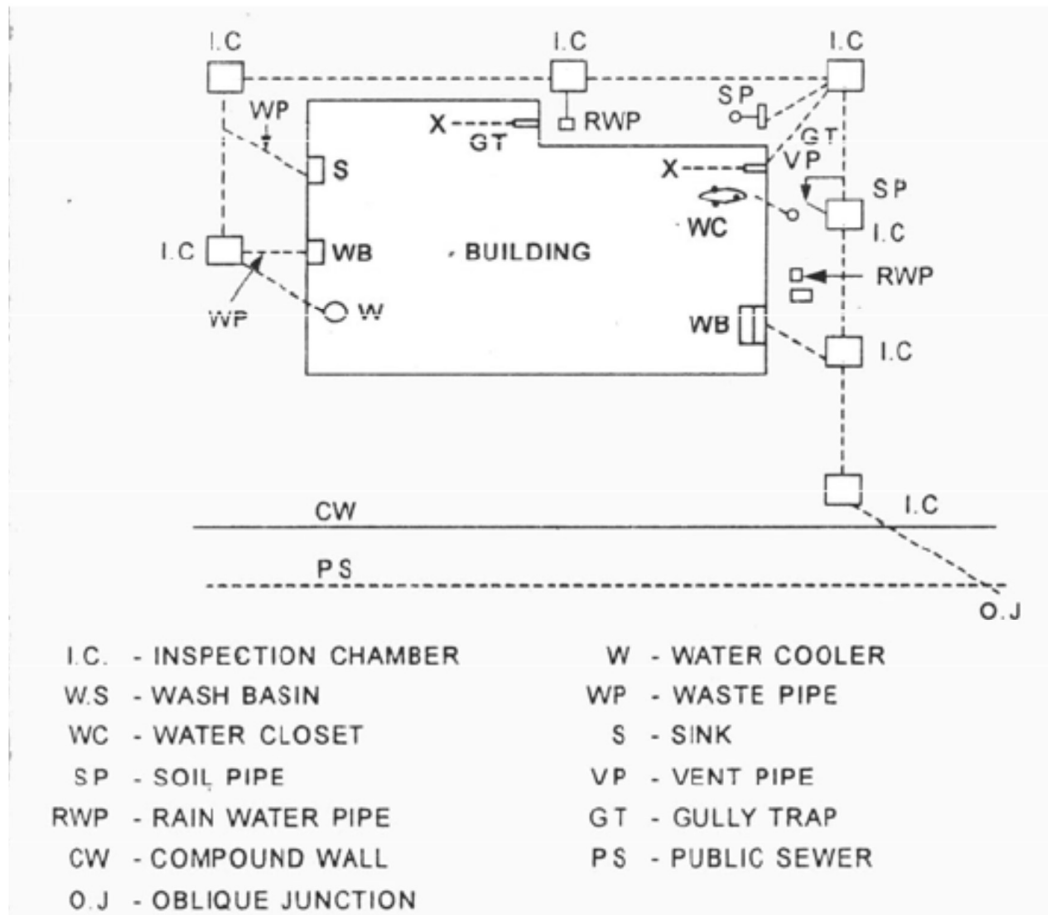

STANDARDS FOR SANITARY CONVENIENCES

Table: 1. Sanitation requirements for shops and Commercial Offices

Sl. No.	Sanitary Unit/ Fittings	For Personnel
1.	Water closet	One for every 25 persons or part thereof, exceeding 15 (including employees and customers). For female personnel 1 for every 15 persons or part thereof, exceeding 10.
2.	Drinking Water Fountain	One for every 100 persons with a minimum of one on each floor.
3.	Wash Basin	One for every 25 persons or part thereof.
4.	Urinals	Nil up to 6 persons 1 for 7-20 persons 2 for 21-45 persons 3 for 40-70 persons 4 for 71-100 persons From 101 to 200 add at the rate of 3%; For over 200 persons add at the rate of 2.5%.
5.	Cleaners' Sink	One per floor minimum, preferably in or adjacent to sanitary rooms.

Table:2 Sanitation Requirements for Hotels

Individual guest rooms shall have attached toilets. In addition, the following shall also be provided.

Sl. No.	Sanitary Unit	For Residential Public staff	For non residential Staff	
			For male	For female
1.	Water Closet (W.C.)	One per 8 Persons omitting occupants of the attached water closet minimum of 2 if both sexes are lodged	1 for 1-15 persons 2 for 16-35 persons 3 for 36-65 persons 4 for 66-100 persons	1 for 1-12 persons 2 for 13-25 persons 3 for 26-40 persons 4 for 41-57 persons 5 for 58-77 persons 6 for 78-100 persons Add 1 for every 6 persons or part thereof
2.	Ablution Taps	One in each W.C	One in each W.C	One in each W.C.
3.	Urinals	Nil	Nil up to 6 persons 1 for 7-20 persons 2 for 21-45 persons 3 for 40-70 persons	Nil

Table:2 Sanitation Requirements for Hotels

4.	Wash Basins	One per 10 persons	1 for 15 persons 2 for 16-35 persons 3 for 36-65 persons 4 for 66-100 persons	1 for 1-12 persons 2 for 13-25 persons 3 for 26-40 persons 4 for 41-57 persons 5 for 58-77 persons 6 for 78-100 persons
5.	Baths	One per 10 persons	Nil	Nil
6.	Cleaner's sinks	One per 10 persons. Less occupants of room with bath in suite	Nil	Nil
7.	Kitchen Sink	One in each Kitchen	One in each Kitchen	One in each Kitchen

Table -12 Sanitary Requirements for Large Stations and Airports

Sl. No.	Place	W.C. for Males	W.C. for Females	Urinals for Males only
1.	Junction Stations, Intermediate Stations and Substations	3 for first 1000 persons, add 1 for subsequent 1000 persons or part thereof.	8 for first 1000 persons, add 1 for every additional 1000 persons or part thereof.	4 for every 1000 person, add 1 for every additional 1000 persons or part thereof.
2.	Terminal Stations and Bus Terminals	4 for first 1000 persons and 1 for every additional 1000 persons or part thereof.	10 for every 1000 person and 1 for every additional 1000 persons or part thereof.	6 for every 1000 person and 1 for every additional 1000 persons or part thereof.
3.	Domestic Airports	2*	4*	1 per 40 persons or part thereof.
	Minimum.			
	For 200 persons			
	For 400 persons			
	For 600 persons			
	For 800 persons			
For 1000 persons				
4.	International Airports	6	20	1 per 40 persons or part thereof.
	For 200 persons			
	For 600 persons			
	For 1000 persons			



SATHYABAMA

INSTITUTE OF SCIENCE AND TECHNOLOGY
(DEEMED TO BE UNIVERSITY)

Accredited "A" Grade by NAAC | 12B Status by UGC | Approved by AICTE

www.sathyabama.ac.in

SCHOOL OF BUILDING AND ENVIRONMENT

DEPARTMENT OF ARCHITECTURE

UNIT - III

SEWAGE TREATMENT

INTRODUCTION

Sewage is a dilute mixture of the various types of wastes from **residential, public and industrial places**.

Sewage contains **99.9% of water** and small portion of solids present in the sewage pose threat as they are offensive in nature, undergo changes by bio-degradation causes nuisance and pollution.

So an understanding the nature of **physical, chemical and biological characteristics** of sewage is essential in planning, design and operation of treatment and disposal facilities and in the engineering management of environmental quality.

STRENGTH OF SEWAGE:

The strength sewage is its potential to produce nuisance to the man and his environment. It is expressed in terms of B.O.D. The nuisance is caused by the oxidizable organic matter, which is unstable in nature, undergoes biodegradation and produces very bad odor and causes insanitary and unhealthy environment.

If the sewage contains **more organic matter it is more strong** and if the sewage contains less organic matter is considered as less strong.

PHYSICAL

Colour:

It indicates the condition of sewage as fresh, stale or septic.

Yellow, grey or light brown colour indicates **fresh sewage**.

Black or dark brown colour indicates **stale sewage**.

Other colors in sewage are due to the presence of industrial wastes, dyes etc

Odour:

Fresh domestic sewage has slightly soapy or oily smell

Stale sewage has of offensive odour due to liberation of hydrogen sulphide and other sulphur compounds

Temperature:

If the temperature of sewage is more, biological activity is more

Turbidity :

It is caused due to the presence of suspended matter and colloidal matter. Sewage is normally turbid

BIOLOGICAL

The sewage may contain micro-organisms like viruses, bacteria, algae, fungi, protozoa, rotifers etc.

These organisms may be aerobic, anaerobic or facultative in nature. "Aerobic bacteria" are those, which can live and grow in the presence of oxygen dissolved in water medium but anaerobic bacteria can survive and grow in absence of oxygen.

"Facultative bacteria" are those, which survive and grow both in presence and absence of oxygen.

PRINCIPLES OF TREATMENT:

REDUCTION OF VOLUME AND STRENGTH:

The following are the methods for the reduction of volume and strength are

- Segregation of uncontaminated wastes from contaminated wastes
- Conservation of water
- Implementing process changes to minimize wastes
- Reusing treated waste water for processes requiring lesser quality of water
- Reduction of strength of waste by process changes equipment modifications, segregation, equalization and by-product recovery

PRINCIPLES OF TREATMENT:

EQUALIZATION:

When the characteristics of industrial waste water vary in a day and also when the discharge rate is not uniform or continuous, the waste may require equalization before treatment. The equalization consists of holding the waste for some designed

NEUTRALIZATION

When the industrial waste contains excessively acidic or alkaline substances the waste water requires neutralization. This becomes very essential particularly in the case of acidic wastes. In the neutralization process the waste is held in the tanks and its PH value is adjusted suitably by either adding alkaline or acidic substances as the case may be.

PROPORTIONING

Proportioning consists of control of the discharge of the industrial waste into the receiving stream or sewer in a fixed proportion to the flow of domestic waste water

This helps not only in protecting the treatment device from shock load, but also improving the sanitary quality of the treated effluent.

SEWERAGE TREATMENT AND DISPOSAL

The sewage treatment units can be broadly classified as

- Primary treatment
- Secondary treatment
- Final treatment

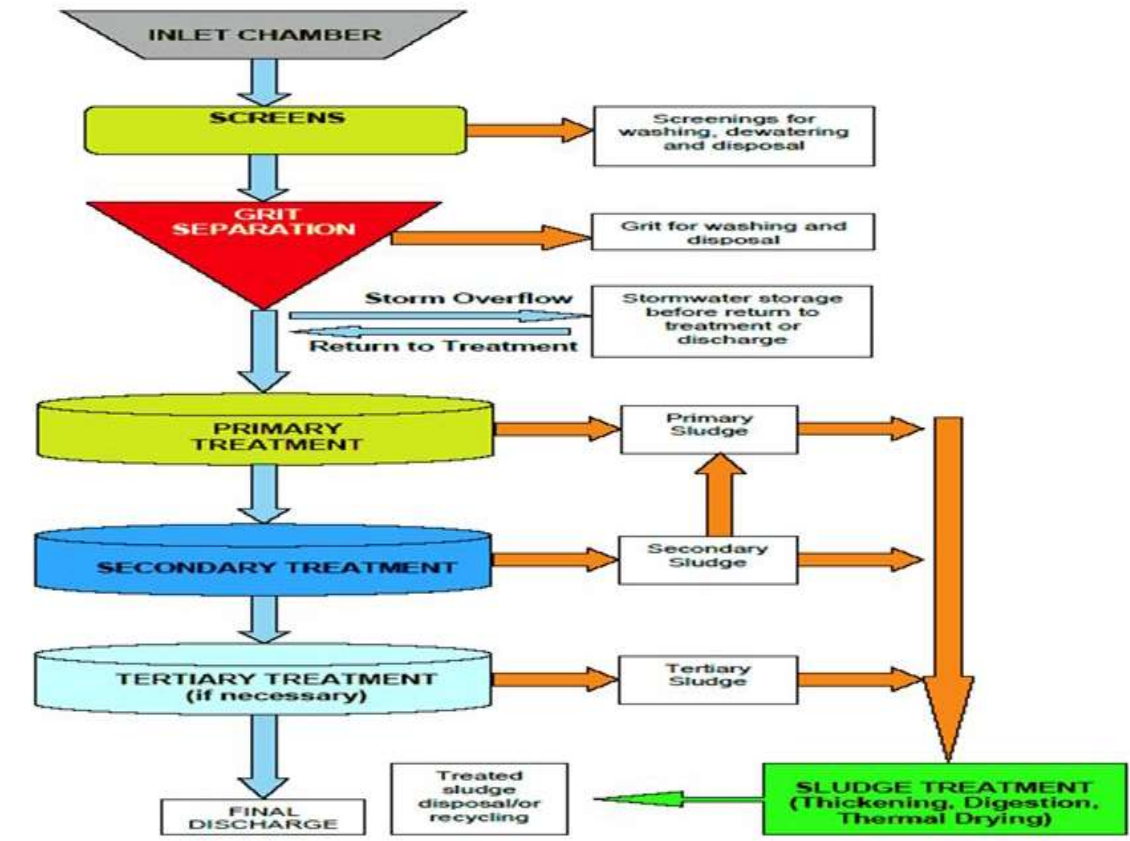

PRIMARY TREATMENT:

In primary treatment, the larger solids from the sewage are removed during the treatment process.

The more complex compounds are broken up and converted into simpler compounds by decomposition.

The primary treatment includes **screen, grit chambers, detritus tanks, skimming tanks and sedimentation tanks with or without use of chemicals.**

SCREENS

The main purpose of the installation of screens is to **remove the floating matter of comparatively large size** to prevent the possible damage of pumps and other equipment's

TYPES OF SCREENS:

Racks or bar-screens

Perforated or fine screens

Comminuters or cutting screens.

LOCATION:

The screens should preferably be located just before grit chambers at an angle of 30° to 60° with the direction of flow.

The screens are some times accommodated in the body of grit chambers.

The screening element may consists of parallel bars, rods, gratings or wire meshes or perforated plates and openings may be of any shape generally they are circular or rectangular.



Mechanical screen with screen housing and ventilation at Koyambedu STP in Chennai. Manual screen and bypass channel screen in between the mechanical and manual screens is also seen

Bar screens

coarse or medium size in which bars are palced 5 cm or above and remove rags , sticks, dead animals etc from the sewageand prevent the sewage pumps against damage as shown in fig

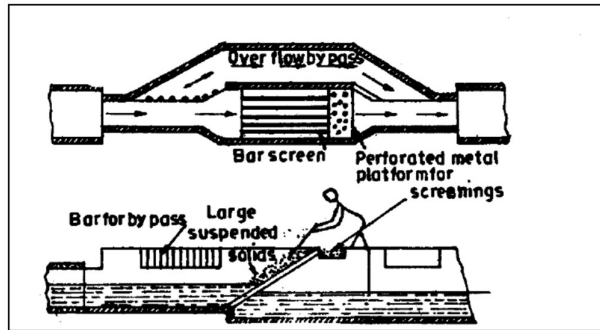

Fine screens

Fine screens have perforations of size about 1.5 mm to 6mm. They produce a noticeable effect on the strength of sewage and they considerably reduce the load on subsequent treatment units. Fine screens may be of drum or disc type and mechanically operated.

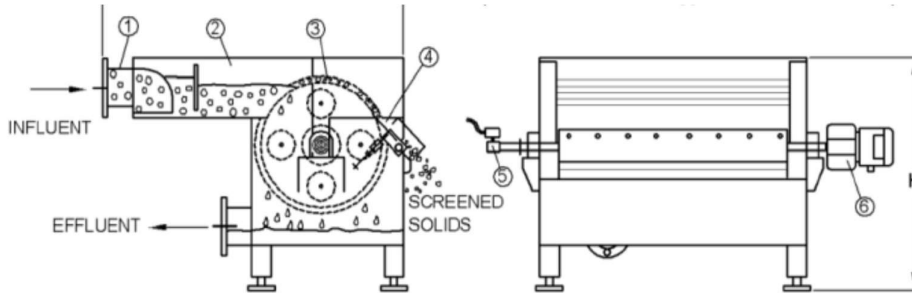
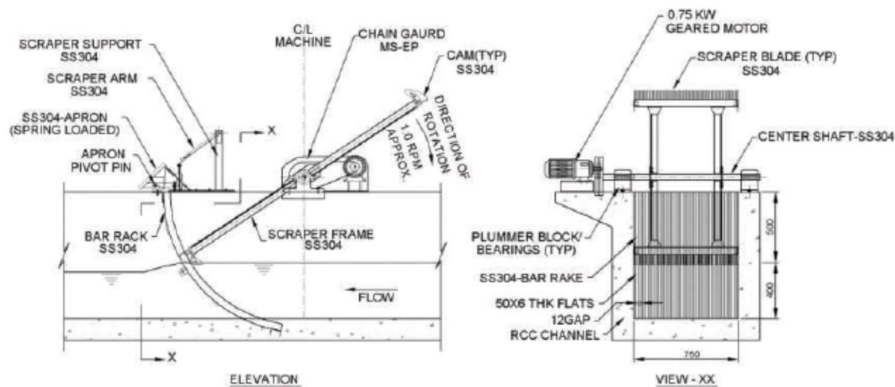

Figure 5.22 Typical rotary drum screen



Typical circular wedge wire screen

SKIMMING TANKS:

These tanks are used to remove oil, grease, soap; wood pieces; fruit skins etc.

AIR DIFFUSERS: Air diffusers are provided at the bottom of the tank for efficient working of skimming tank. The period of aeration and quantity of air will depend upon the quality of sewage. The compressed air sets up the currents and it results in the floating matter of sewage

COLLECTION OF FLOATING SUBSTANCES:

The floating substances collected at the top of tank are removed either with hand or with the help of mechanical equipment

DETENTION PERIOD: The detention period of about 3 to 5 minutes are designed

OUTLET: The submerged outlet is provided to prevent the floating substances into the outlet channel

SHAPE: The shape skimming tank may be elliptical or circular and depth may be about one metre or so

GRIT CHAMBERS:

The purpose of providing grit chamber in the sewage treatment process is to remove grit, sand and other organic matter by reducing velocity of flow so that the heavier organic materials settle down at the bottom of grit chamber and the lighter organic materials are carried forward for further treatment.

Both quality and quantity of grit varies depending upon

- types of street surfaces encountered
- relative areas served
- climatic conditions
- types of inlets and catch basins
- amount of storm water diverted from combined sewers at overflow points
- sewer grades
- construction and condition of sewer system
- ground and ground water characteristics (i) industrial wastes
- relative use of dumping chutes or pail depots where night soil and other solid wastes are admitted to sewers and
- social habits.

LOCATION:

- The grit chambers are placed after pumping stations and before screens or may be changed to suit the local requirements.

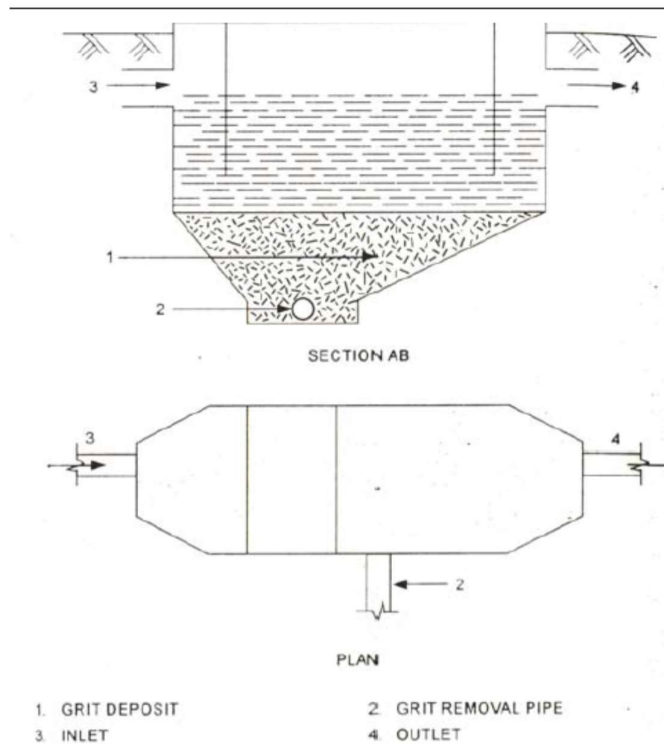

CLEANING INTERVAL: depending upon the local conditions cleaning interval varies from one to two weeks.

DEPTH: A minimum of 300mm should be provided and depth to length ratio should be about 1/16.

DETENTION PERIOD: The grit chambers are designed for a detention period of about 1 minute.

SPACE FOR ACCUMULATION OF GRIT: It is necessary to provide sufficient space at the bottom of grit chamber for accumulation of grit which may be 12 to 27 litres per one million litres of sewage.

VELOCITY OF FLOW: The velocity of flow in the grit chamber is kept 200 to 300 mm per sec. This is obtained by dividing the grit chamber into compartments.

DISPOSAL OF GRIT:

The disposal of grit is used to reclaim the low lying land. It can also mixed with poor soil to condition it and acts as good manure for garden crops.

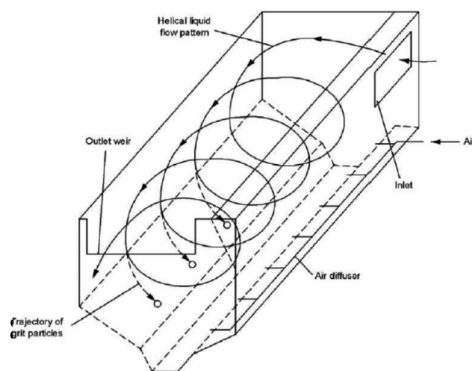

Source: EPA

Figure 5.29 Aerated grit chamber

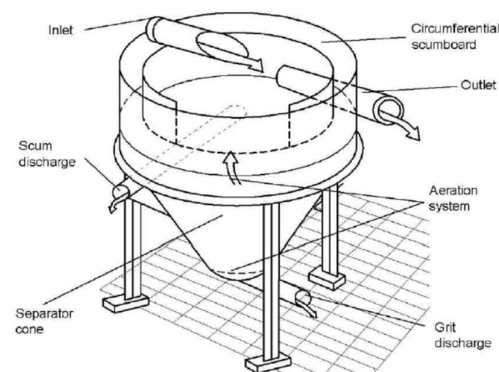

Figure 5.28 Hydraulic regimen of vortex and scum grit separator

SETTLING TANKS

The **PRIMARY CLARIFIER** is located after screens and grit chambers and reduces the organic load on secondary treatment units.

It is used to remove

- (i) inorganic suspended solids or grit if it is not removed in grit chamber described earlier,
- (ii) Organic and residual inorganic solids, free oil and grease and other floating material and
- (iii) chemical flocs produced during chemical coagulation and flocculation.

SECONDARY CLARIFIER is located after the biological reactor and is used to separate the bio-flocculated solids or bioflocs of biological reactors.

In some cases where two stage bio reactors are used, the clarifiers after the first stage of bioreactor is referred to as **intermediate clarifiers**.

TYPES OF SETTLING

Mainly , four categories of settling occur, depending on the tendency of particles to interact and their concentration.

These settling types are

- (i) **Discrete settling**
- (ii) **Flocculent settling**
- (iii) **Hindered or zone settling**
- (iv) **Compression.**

Discrete settling

Discrete particles do not change their size, shape or mass during settling. Grit in sewage behaves like discrete particles.

Flocculent settling

Flocculent particles coalesce during settling, increasing the mass of particles and settle faster. Flocculent settling refers to settling of flocculent particles

Hindered or zone settling

When concentration of flocculent particles is in intermediate range, they are close enough together so that their velocity fields overlap causing hindered settling. The particles maintain their relative positions with respect to each other and the whole mass of particles settles as a unit or zone.

Compression

In compression zone, the concentration of particles becomes so high that particles are in physical contact with each other, the lower layers supporting the weight of upper layers.

Depth and Detention Time

It is seen that depths of primary clarifiers vary from 2.4 m to 4.2 m with detention times varying from 1.65 hours to 4 hours.

In secondary clarifiers, the depths vary from 2.4 m to 4.2 m and detention times vary from 2.2 hours to 4.2 hours.

SEDIMENTATION PROCESS:

When the velocity of flow is decreased or when sewage is allowed to stand at rest, the suspended particles carried by the sewage tend to settle at the bottom of tanks. The material collected at the bottom of sedimentation tanks is known as sludge and partially treated sewage is known as effluent, both require further additional treatment to make them an objectionable.

TYPES OF TANKS:

According to the nature of working

- Fill and draw type.
- Continuous flow type.

According to the location

- Primary clarifies before grit chambers.
- Secondary clarifies after filters or activated sludge process.

SHAPE OF TANK:

Rectangular tanks: The ratios of length to width is about 4 to 5 and the ratio of width to depth is about 2 to 3. A rectangular tank with horizontal flow is as shown in fig

Circular tank: The circular tanks are with vertical flow and it is possible to install conveniently the mechanical scrapers to collect the sludge at bottom of tank

Hopper bottom tank:

These tanks may be with horizontal or vertical flow. Hopper bottom tank with vertical flow

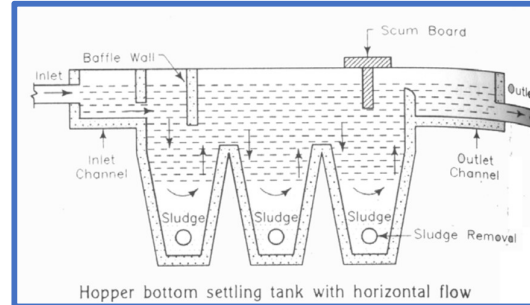
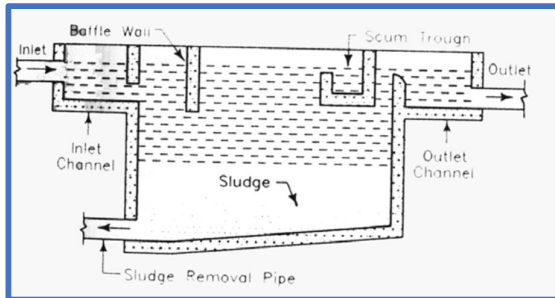

SECONDARY TREATMENT

The effluent that is coming out from primary clarifies contains 45 to 50 percent of the unstable or organic matter originally present in the sewage as solution or suspension or colloidal matter. The sewage to this extent is prepared to receive the **SECONDARY TREATMENT**.

The main function of the secondary treatment of sewage is to convert the remaining organic matter into stable form by oxidation or nitrification.

The secondary treatment involves the following methods.

Filtration (attached growth process)

Activated sludge process. (suspended growth process)

The filters which are commonly employed in the secondary treatment of sewage are of following types

- **Contact beds.**
- **Intermittent sand filters.**
- **Trickling filters**

TRICKLING FILTERS

Trickling filters are used for the biological treatment of domestic and industrial wastes, which are **amenable to aerobic biological process**.

The sewage is allowed to sprinkle or to trickle over bed of coarse, rough, hard material and it is then collected through the under drainage system. **The oxidation of the organic matter is carried out under aerobic conditions.**

A bacteria film known as bio film is formed around the particles of filtering media and for the existence of this film oxygen is supplied by intermittent working of the filter and by provision of suitable ventilation facilities in the body of the filter.

The colour of film is blackish, greenish and yellowish and consists of bacteria, algae, fungi, lichens, protozoa etc.

The trickling filters are broadly divided into the following categories.

1. Standard rate trickling filter.

2. High rate trickling filter.

MOVABLE DISTRIBUTORS:

Rotary distributors: These rotate around a central support and suitable for circular filters.

Rectilinear distributors: These move back and forth from one to other end, suitable for rectangular filters.

FIXED DISTRIBUTORS:

These are spray nozzles discharge the sewage in the form of fine drops, which are fixed on the surface of filter at appropriate distances and suitable for small installations.



Rectilinear distributors

Rotary distributors

Standard rate trickling filter

The filter media of trickling filter may consist of excused rock or clinker or specially manufactured material of uniform size varies from **30mm to 80mm** approximately cubical in shape and free from flat, elongated pieces, dirt or any other undesirable materials

The floor of trickling filter is generally made of R.C.C. of 100 to 150 mm thick and slope towards central drain or towards periphery of filter as shown in figure

The trickling filter should be provided with suitable under drainage system to collect the sewage after it has passed through the filter media at the bottom of filter and sent for further treatment or disposal.

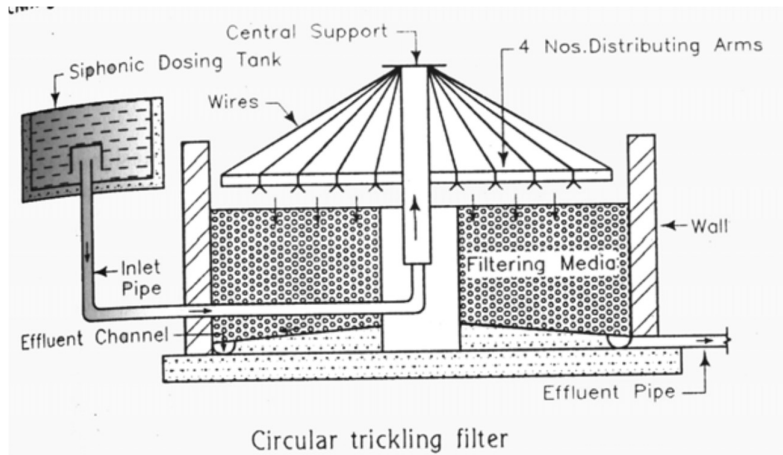

The shape of trickling filter may be circular or rectangular, the former is being very common.

High Rate trickling filter

High Rate Filters In case of high rate trickling filters the settled sewage is applied at much higher rate than for the low rate filter.

The high rate filters of modern advancements also function on the same lines and having the same construction detail but with the difference that provision is made in them for recirculation of sewage through the filter by pumping a part of the filter effluent to the primary settling tank (or the dosing tank of trickling filter) and re-passing it through filter.

Recirculation of High Rate Trickling Filters

To increase the load rate of trickling filter the sewage is an essential and important feature of high rate filters. The recirculation consists in returning portion of the treated or partly treated sewage to the treatment process (i.e. filter).

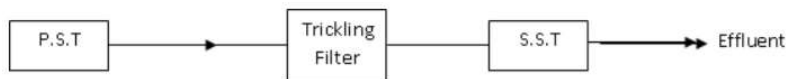

Low Rate/Standard Trickling Filter (No Recirculation)

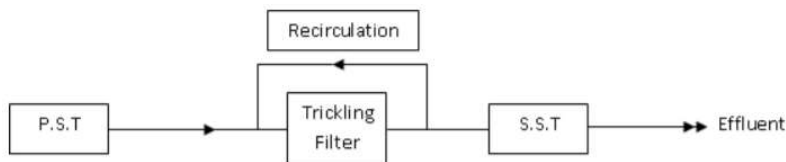

Single Stage High Rate Trickling Filter

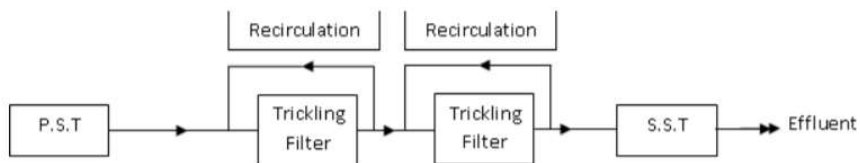

Two Stage High Rate Trickling Filter

ACTIVATED SLUDGE PROCESS

An ASP essentially consists of the following:

- (i) **Aeration tank** containing microorganisms in suspension in which the reaction takes place,
- (ii) Activated sludge recirculation system,
- (iii) Excess sludge wasting and disposal facilities,
- (iv) Aeration systems to transfer oxygen and
- (v) Secondary sedimentation tank to separate and thicken activated sludge.

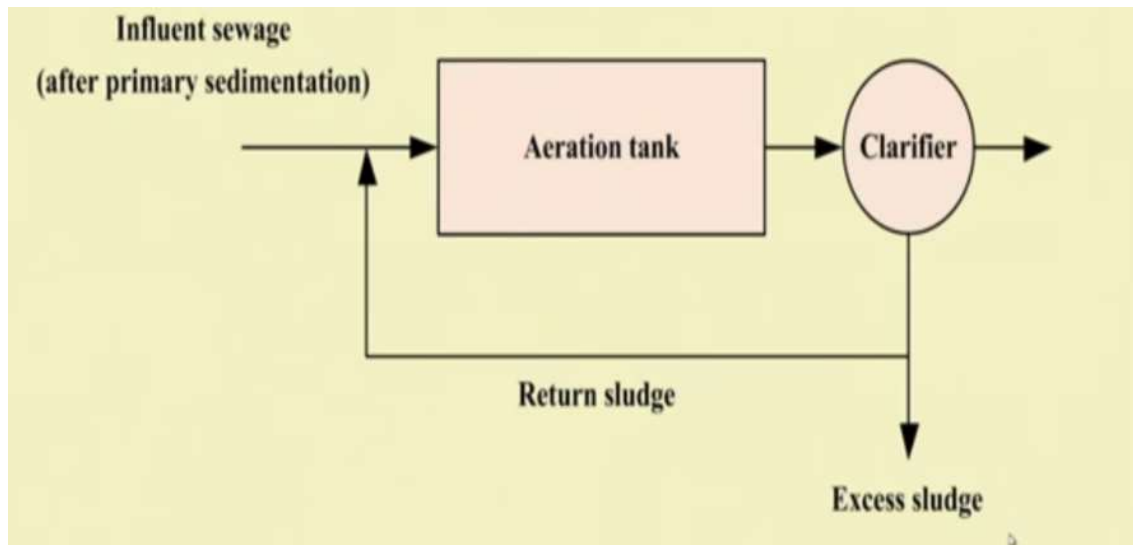

The influent sewage after primary sedimentation is fed into a aerator system. And, then in the aeration tank where the mixing aeration and oxygen supply takes place

After aeration is done the effluent goes to a clarifier, and the not entirely treated sewage is allowed to settle down. So, that way you can say it maybe effluent

The sludge settled sludge is collected, out of the settled sludge part of sludge is wasted, which is actually excess sludge while the part of sludge (25 to 50 percent) is again recycled back to the aeration tank aeration system.

This is actually advantageous in terms of managing the required amount of biomass in the system.

The term activated sludge is used to indicate the sludge which is obtained by settling sewage in presence of **abundant oxygen**.

The activated sludge is biologically active and it contains a great number of aerobic bacteria and other micro-organisms which have got an unusual property to oxidize the organic matter.

The following are the properties of activated sludge.

1. The activated sludge contains fertilizing constituents.
2. The colour of activated sludge indicates the degree of aeration.

Light brown – under aerated sludge.

Golden brown – well aerated sludge.

Muddy brown – over aerated sludge.

3. Moisture content of activated sludge is about 95 to 97 percent

SEPTIC TANK | DESIGN AND INFORMATION

A Septic Tank is simply a **big concrete, brick, fiberglass or polyethylene tank, buried in the ground that takes all the wastewater from the house**. The septic tank was invented in the 1860's and is the original piece of sewage equipment used for the treatment of sewage in rural areas.

Septic tanks are a minimum of **2700 litres for a 2 bedroom house**.

Wastewater flows into the tank at one end and leaves it at the other. A brick or concrete septic tank looks something like this in cross-section:

Disposal of sewage from isolated buildings

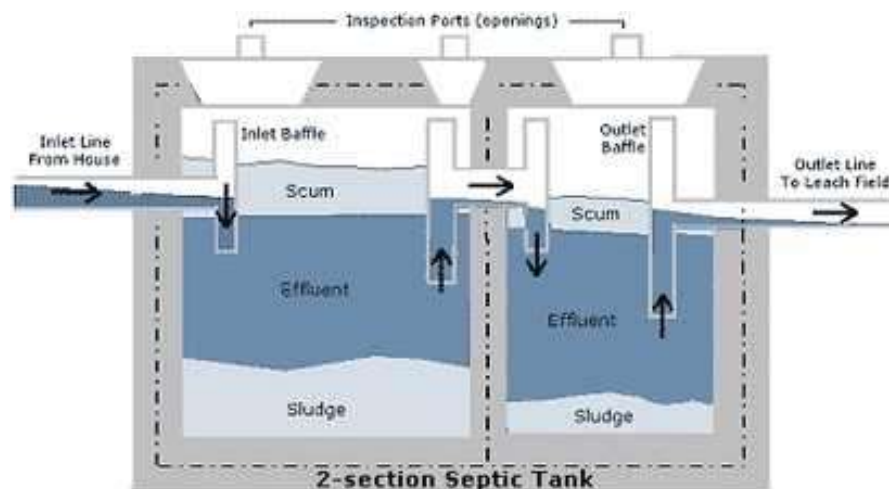

Septic Tank | Design and Information

The tank is divided into two sections. The first section is the **primary settlement tank (PST)** and the second section is the **secondary settlement tank (SST)**. The sewage enters the PST from the sewer pipes in the house.. Anything that floats rises to the top of the tank **and**

aerobic bacteria colonize it, digesting the organic material and preventing the effluent from becoming too septic. This layer known as the **scum layer or crust**.

Anything **heavier than water sinks to the bottom to form the sludge layer**. In the middle is a relatively clear effluent layer. This body of effluent contains anaerobic bacteria and chemicals like nitrogen and phosphorous, plus a fairly large proportion of suspended solids – tiny bits that float around in the water. The effluent then transfers via a baffle, pipe or weir to the SST where the process is repeated.

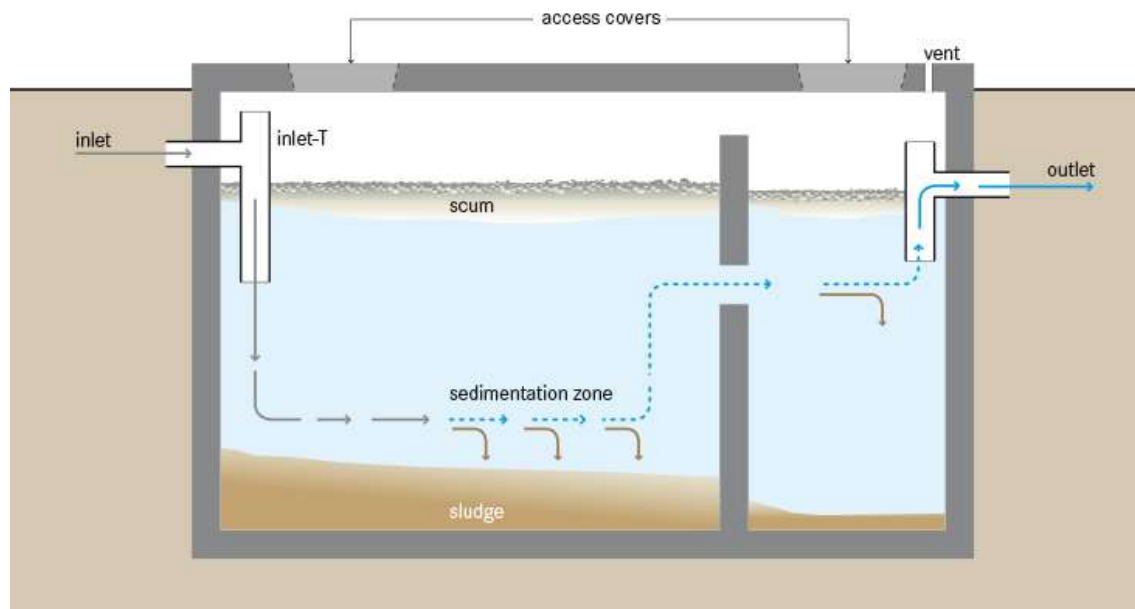

CONSTRUCTION:

The septic tank should be water tight and material used are resistant to corrosion

The septic tank should be such that the **direct currents are not established between inlet and outlet** by using submerged pipes or baffle walls near the inlet.

The septic tank should provide proper ventilation by **air vent pipes**.

The top cover of septic tank should be made of R.C.C and a manhole is provided in RCC slab for the purpose of inspection and cleaning. If necessary, C.I. steps may be provided.

The sludge is allowed to be accumulated at the bottom of tank and it is removed at intervals by pumping.

SOAK PIT:

It is a circular or square pit of sufficient dimension. The total depth of soak pit varies from 1.2 to 1.8m. The pit is filled with brick bats or coarse aggregates. The effluent is applied into the pit so that aerobic bacteria film on the surface of brick bat oxidizes the dissolved organic matter.

The waste water then percolates into the ground and thus finally disposed. The size of the pit depends upon the quantity of effluent and permeability of subsoil.

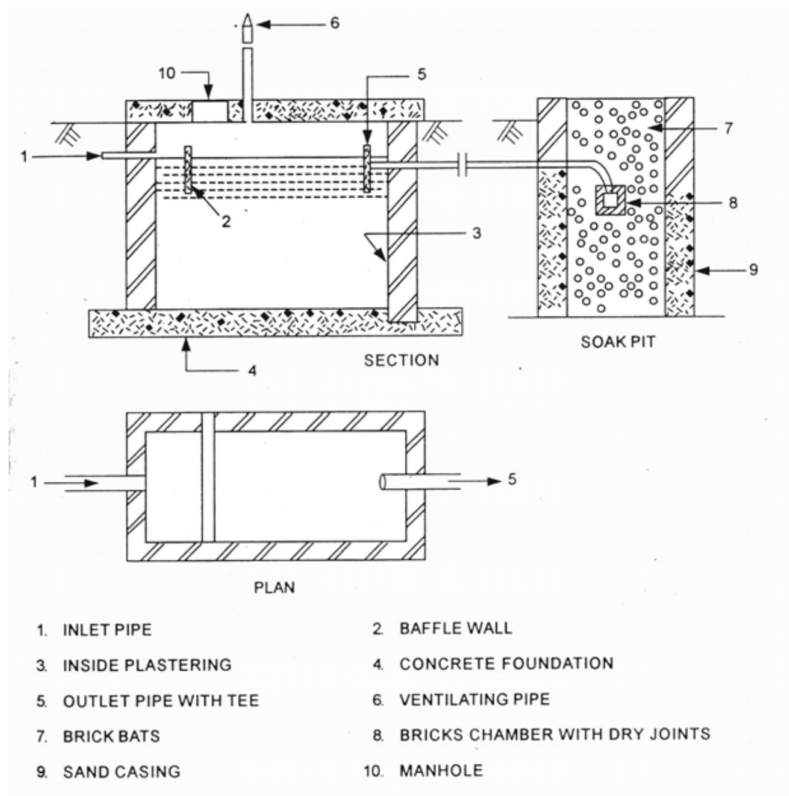

Disposal of sewage in Villages

Pit privy

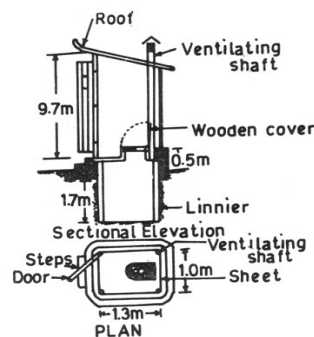

This is very economical and requires no operation.

1.3 X 1 meter in plan and 1.5 to 2.8 in deep. At the top of the pit squatting seat is provided.

The superstructure is of temporary nature. When the pit is filled, it is closed from the top by 60 cm thick earth layer and a new pit is excavated by the side of it.

The squatting pan along with the compartment is shifted to the new trench.

10 cm diameter vent -to take the foul gases. Pit privy should be constructed 30 in away from the existing well in the nearby locality.

Bore-hole privy

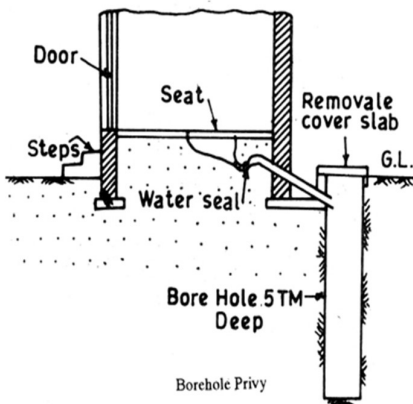

Similar to pit privy, the only difference is that in place of a pit, it has long 40 cm diameter hole. The depth of the bore hole should be 100 cm less than the ground water table, so that the excreta may not pollute the ground water. The hole should be lined from inside. When the hole is filled up, it is covered by a thick layer of soil and another hole is dug by the side of it. Fig shows the improved borehole privy in which the hole provided by the side of the latrine compartment and is connected to the squatting seat by means of a trap. This improved type of privy will also avoid fly nuisance and odour.

Concrete - Vault Privy

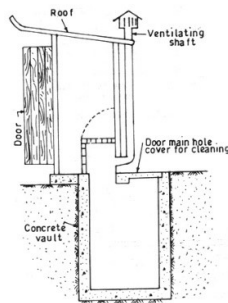

If water table is very close to the ground surface, borehole, pit or other types of privies, cannot be constructed as excremental matter will pollute the ground water.

It essentially consists of a watertight concrete vault constructed in the ground. Squatting pan with compartment is placed over the concrete vault as shown in the fig.

Squatting pan should be constructed in such a way that no water can enter the vault.

Aqua Privy

Aqua privy is a permanent structure. It essentially consists of underground masonry chamber. The squatting pan is enclosed inside small rooms are fixed the top of the masonry tank with the outlet ends dipped 8-10 cm, in the liquid below.

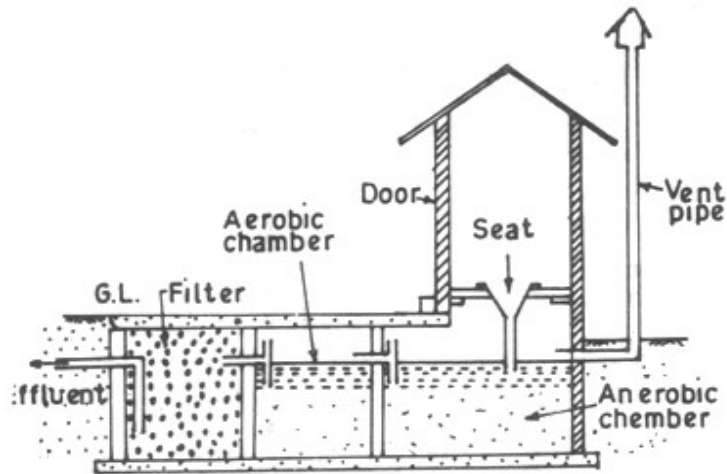

The solid waste directly goes in the masonry chamber and is digested anaerobically and then aerobic action takes place and the sewage is digested. The effluent from second chamber is allowed to pass through a filter tank.

The final effluent is very, clear and can be utilized for irrigating gardens or directly disposed of in nearby water courses



SATHYABAMA

INSTITUTE OF SCIENCE AND TECHNOLOGY
(DEEMED TO BE UNIVERSITY)

Accredited "A" Grade by NAAC | 12B Status by UGC | Approved by AICTE

www.sathyabama.ac.in

SCHOOL OF BUILDING AND ENVIRONMENT

DEPARTMENT OF ARCHITECTURE

UNIT - IV

ENVIRONMENTAL SANITATION

INTRODUCTION

The term **ENVIRONMENT** is defined as all the systems namely atmosphere, lithosphere, hydrosphere (non living components) and biosphere (living components) surroundings us.

It includes air, water, food, the pollutions, waste materials and other ecological problems, which effect the life and health of human beings and other life.

The term **ENVIRONMENTAL HYGIENE** is the conditions or practices helpful in maintaining the basic healthy environmental conditions for human and for preventing diseases, especially through cleanliness. For example clean water supply, proper human and animal waste disposal, protection of food from contamination, and clean home , all of which are concerned with the quality of the human environment

SANITATION is the process of keeping places clean and healthy, especially by providing a clean water supply and proper sewage system to prevent human contact with waste. All human waste and liquid wastes from all sanitation facilities including toilets must be disposed of safely.

Maintaining network-based sewerage systems, recycling and reusing of treated waste water, promoting proper disposal and treatment of sludge from on-site installations (septic tanks, pit latrines), ensuring safe collection of all human wastes and their subsequent disposal after treatment are some of the measures for good sanitation.

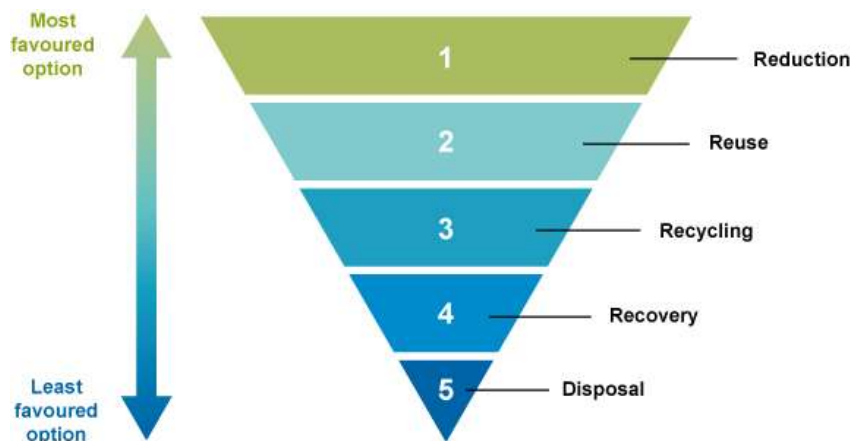

The **WASTE HIERARCHY** ranks the different ways of dealing with waste in order of desirability. At the top is **waste reduction**, which means not generating waste in the first place or minimising the amount of waste produced. Below that is **waste reuse** (for example, refilling a drinks bottle), followed by **recycling** (processing of wastes into new raw materials). A fourth option is the **recovery** of energy by burning or biological treatment. **Disposal**, ideally in a landfill site, is the final option for any wastes that cannot be dealt with in any other way. A landfill site is an area of land set aside for the final disposal of solid waste.

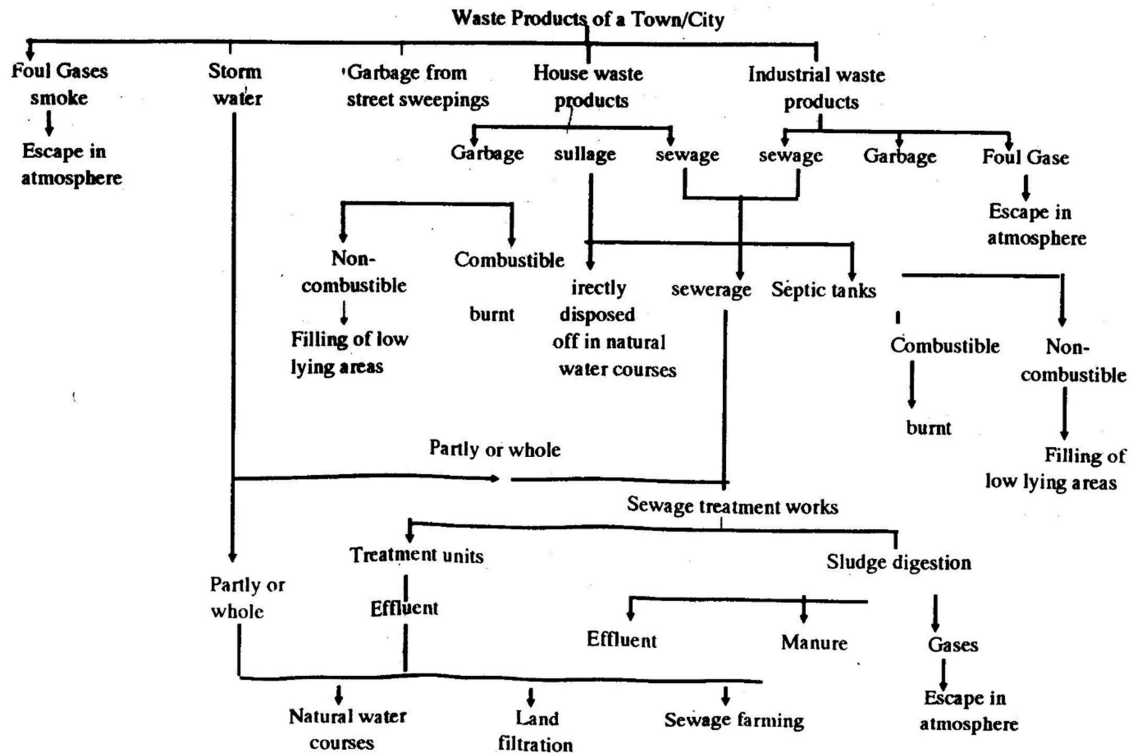

Table 1.1 outlines of sanitary engineering

SOLID WASTE

Solid wastes are the **organic** and **inorganic** waste materials such as

- kitchen refuse
- grass clippings
- Tree foliage
- product packaging
- furniture
- clothing
- bottles
- paper appliances
- paint cans
- Batteries etc. which produced in a society

Solid wastes are classified on the basis of source of generation and type

CLASSIFICATION OF WASTE

SOURCE BASED CLASSIFICATION

Residential

This refers to wastes from dwellings, apartments, etc., and consists of leftover food, vegetable peels, plastic, clothes, ashes, etc.

Commercial

This refers to wastes consisting of leftover food, glasses, metals, ashes, etc., generated from stores, restaurants, markets, hotels, motels, auto-repair shops, medical facilities, etc

Institutional

This mainly consists of paper, plastic, glasses, etc., generated from educational, administrative and public buildings such as schools, colleges, offices, prisons, etc.

Municipal

This includes dust, leafy matter, building debris, treatment plant residual sludge, etc., generated from various municipal activities like construction and demolition, street cleaning, landscaping, etc

Industrial

This mainly consists of process wastes, ashes, demolition and construction wastes, hazardous wastes, etc., due to industrial activities.

Agricultural

This mainly consists of spoiled food grains and vegetables, agricultural remains, litter, etc., generated from fields, orchards, vineyards, farms, etc.

TYPES BASED CLASSIFICATION

Garbage

This refers to animal and vegetable wastes resulting from the handling, sale, storage, preparation, cooking and serving of food. Garbage comprising these wastes contains putrescible (rotting) organic matter, which produces an obnoxious odour and attracts rats and other vermin. It, therefore, requires special attention in storage, handling and disposal



Ashes and residues

These are substances remaining from the burning of wood, coal, charcoal, coke and other combustible materials for cooking and heating in houses, institutions and small industrial establishments. produced in large quantities, as in power-generation plants and factories, these are classified as industrial wastes. Ashes consist of fine powdery residue, cinders and clinker often mixed with small pieces of metal and glass. Since ashes and residues are almost entirely inorganic, they are valuable in landfills.

Combustible and non-combustible wastes

These consist of wastes generated from households, institutions, commercial activities, etc., excluding food wastes and other highly putrescible material. Typically, while combustible material consists of paper, cardboard, textile, rubber, garden trimmings, etc., non-combustible material consists of such items as glass, crockery, tin and aluminum cans, ferrous and non-ferrous material and dirt.



Bulky wastes

These include large household appliances such as refrigerators, washing machines, furniture, crates, vehicle parts, tyres, wood, trees and branches. Since these household wastes cannot be accommodated in normal storage containers, they require a special collection mechanism.

Street wastes

These refer to wastes that are collected from streets, walkways, alleys, parks and vacant plots, and include paper, cardboard, plastics, dirt, leaves and other vegetable matter. Littering in public places is indeed a widespread and acute problem in many countries including India, and a solid waste management system must address this menace appropriately.



Biodegradable and non-biodegradable wastes:

Biodegradable wastes mainly refer to substances consisting of organic matter such as leftover food, vegetable and fruit peels, paper, textile, wood, etc., generated from various household and industrial activities. Because of the action of micro-organisms, these wastes are degraded from complex to simpler compounds. Non-biodegradable wastes consist of inorganic and recyclable materials such as plastic, glass, cans, metals, etc.

Construction and demolition wastes

These are wastes generated as a result of construction, refurbishment, repair and demolition of houses, commercial buildings and other structures. They consist mainly of earth, stones, concrete, bricks, lumber, roofing and plumbing materials, heating systems and electrical wires and parts of the general municipal waste stream.



Farm wastes:

These wastes result from diverse agricultural activities such as planting, harvesting, production of milk, rearing of animals for slaughter and the operation of feedlots. In many areas, the disposal of animal waste has become a critical problem, especially from feedlots, poultry farms and dairies.

Hazardous wastes

wastes of industrial, institutional or consumer origin that are potentially dangerous either immediately or over a period of time to human beings and the environment. This is due to their physical, chemical and biological or radioactive characteristics like ignitability, corrosivity, reactivity and toxicity. Note that in some cases, the active agents may be liquid or gaseous hazardous wastes.

These are, nevertheless, classified as solid wastes as they are confined in solid containers. Typical examples of hazardous wastes are empty containers of solvents, paints and pesticides, which are frequently mixed with municipal wastes and become part of the urban waste stream. Certain hazardous wastes may cause explosions in incinerators and fires at landfill sites.

Others such as pathological wastes from hospitals and radioactive wastes also require special handling. Effective management practices should ensure that hazardous wastes are stored, collected, transported and disposed of separately, preferably after suitable treatment to render

SOLID WASTE MANAGEMENT SYSTEM

A SWM system refers to a combination of various functional elements associated with the management of solid wastes. The system, when put in place, facilitates the collection and disposal of solid wastes in the community at minimal costs, while preserving public health and ensuring little or minimal adverse impact on the environment. The functional elements that constitute the system are



FLOW CHART SWM system

Typical SWM System: Functional Elements

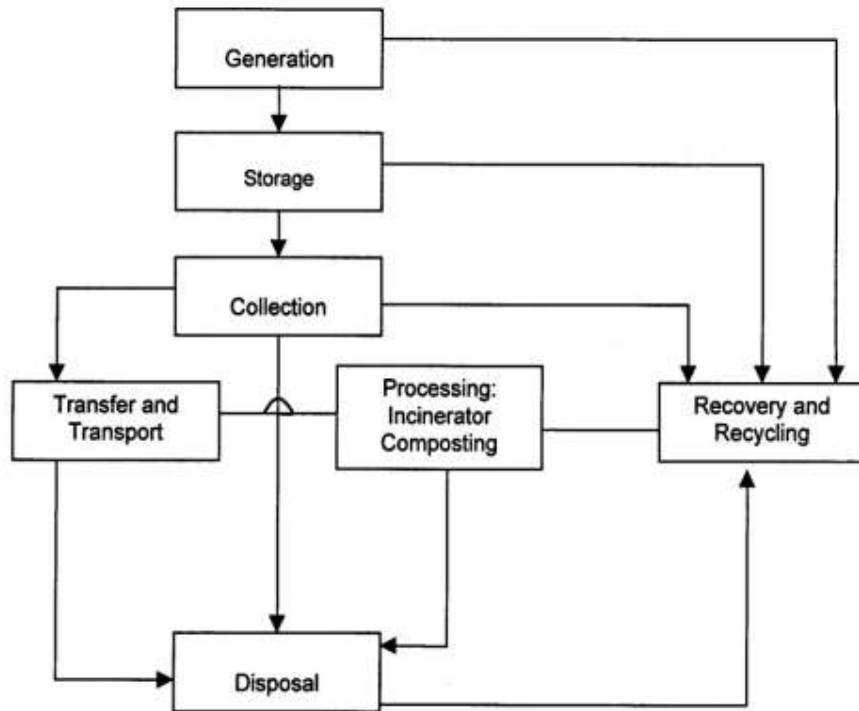

Waste generation:

Wastes are generated at the start of any process, and thereafter, at every stage as raw materials are converted into goods for consumption. wastes are generated from households, commercial areas, industries, institutions, street cleaning and other municipal services. The most important aspect of this part of the SWM system is the identification of waste.

Waste quantum:

The per capita waste generation rate is about 500g/day.

This along with increased population has contributed to higher total waste generation quantum.

Waste Generation Statistics

Year	Per capita waste generated (g/day)	Total urban municipal waste generated (Mt/year)
1971	375	14.9
1981	430	25.1
1991	460	43.5
2000	500	48.8
2010	600	~70.2

Waste storage:

Storage is a key functional element because collection of wastes never takes place at the source or at the time of their generation. The heterogeneous wastes generated in residential areas must be removed within 8 days due to shortage of storage space and presence of biodegradable material. Onsite storage is of primary importance due to aesthetic consideration, public health and economics involved. Some of the options for storage are plastic containers, conventional dustbins (of households), used oil drums, large storage bins (for institutions and commercial areas or servicing depots), etc. Obviously, these vary greatly in size, form and material

Waste Composition:

Studies reveal that the percentage of the organic matter has remained almost static at 41% in the past 3 decades, but the recyclables have increased from 9.56% to 17.18%

Composition of Urban Solid Waste in Indian Cities (Percentage by weight)

City	Paper	Metals	Glass	Textiles	Plastic*	Ash and Dust	Organics	Others**
Chennai	5.90	0.70	-	7.07	-	16.35	56.24	13.74
Delhi	5.88	0.59	0.31	3.56	1.46	22.95	57.71	7.52
Kolkata	0.14	0.66	0.24	0.28	1.54	33.58	46.58	16.98
Bangalore	1.50	0.10	0.20	3.10	0.90	12.00	75.00	7.20
Ahmedabad	5.15	0.80	0.93	4.08	0.69	29.01	48.95	10.39
Mumbai	3.20	0.13	0.52	3.26	-	15.45	59.37	18.07

Waste collection:

This includes gathering of wastes and hauling them to the location, where the collection vehicle is emptied, which may be a transfer station (i.e., intermediate station where wastes from smaller vehicles are transferred to larger ones and also segregated), a processing plant or a disposal site.

Collection depends on the number of containers, frequency of collection, types of collection services and routes. Typically, collection is provided under various management arrangements, ranging from municipal services to franchised services, and under various forms of contracts.

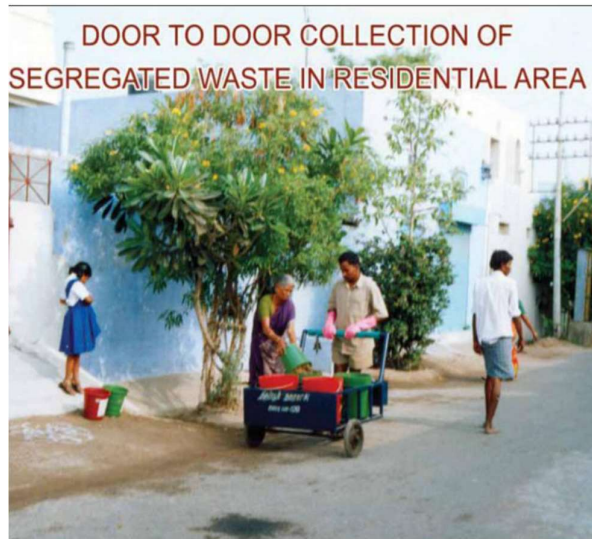

The dry refuse is generally collected in the following systems

- **One-bin system**
- **Two-bin system (Garbage and other rubbish.)**
- **Three-bin system (Garbage, Inorganic ash, grit etc and other rubbish.)**

The following factors, which affect the collection of refuse for disposal, are

- Location of dustbins
- Type of bin system
- Frequency of collection
- Population density
- Number of workers per truck
- Time of collection
- Collection routes
- Cost of collection

Transfer and transport

This Functional element involves:

- The transfer of wastes from smaller collection vehicles, where necessary to overcome the problem of narrow access lanes, to larger ones at transfer stations;
- The subsequent transport of the wastes, usually over long distances, to disposal sites.
- The factors that contribute to the designing of a transfer station include the type of transfer operation, capacity, equipment, accessories and environmental requirements.

The vehicles used for transporting the refuse from the collection points to the disposal point are

Auto-rickshaws of capacity

0.5. to 0.75 tonnes

Trailers of capacity

2 to 3 tonnes

Trucks of capacity

5 to 10 tonnes

Processing

Processing is required to alter the physical and chemical characteristics of wastes for energy and resource recovery and recycling. The important processing techniques include compaction, thermal volume reduction, manual separation of waste components, incineration and composting.

Recovery and recycling

- This includes various techniques, equipment and facilities used to improve both the efficiency of disposal system and recovery of usable material and energy.
- Recovery involves the separation of valuable resources from the mixed solid wastes, delivered at transfer stations or processing plants.
- It also involves size reduction and density separation by air classifier, magnetic device for iron and screens for glass. The selection of any recovery process is a function of economics, i.e., costs of separation versus the recovered-material products.
- Certain recovered materials like glass, plastics, paper, etc., can be recycled as they have economic value.

Waste disposal

- Disposal is the ultimate fate of all solid wastes, be they residential wastes, semi-solid wastes from municipal and industrial treatment plants, incinerator residues, composts or other substances that have no further use to the society.
- Thus, land use planning becomes a primary determinant in the selection, design and operation of landfill operations. A modern sanitary landfill is a method of disposing solid waste without creating a nuisance and hazard to public health.
- Generally, engineering principles are followed to confine the wastes to the smallest possible area, reduce them to the lowest particle volume by compaction at the site and cover them after each day's operation to reduce exposure to vermin.
- One of the most important functional elements of SWM, therefore, relates to the final use of the reclaimed land.

BIOLOGICAL PROCESSES

(a) Aerobic processes: Windrow composting, aerated static pile composting and in-vessel composting; vermi-culture etc.

(b) Anaerobic processes: Low-solids anaerobic digestion (wet process), high solids anaerobic digestion (dry process) and combined processes

THERMAL PROCESSES

(a) Combustion systems (Incinerators): Thermal processing with excess amounts of air.

(b) Pyrolysis systems: Thermal processing in complete absence of oxygen (low temperature).

(c) Gasification systems: Thermal processing with less amount of air (high temperature)..

OTHER PROCESSES

New biological and chemical processes which are being developed for resource recovery from MSW are:

- (a) Fluidised bed bio-reactors for cellulose production and ethanol production.
- (b) Hydrolysis processes to recover organic acids.
- (c) Chemical processes to recover oil, gas and cellulose.

The economical viability of these processes is yet to be established.

CLASSIFICATION OF SEWAGE:

Storm Sewage

Which includes surface runoff developed during and immediately after rainfall over the concerned area.

Sanitary Sewage

Which includes the liquid wastes of domestic and industrial places. This sewage is extremely foul in nature and required to be disposed of very carefully

SYSTEMS OF SEWERAGE METHODS

- CONSERVANCY SYSTEM
- WATER CARRIAGE SYSTEM

CONSERVANCY SYSTEM

In this system various types of

- **refuse and storm water are collected, conveyed and disposed off separately**
- This method is also called **dry system** and is in practice from very ancient times.
- This method is adopting in **small towns, villages and undeveloped portions** of large city even it is out of date system.
- In this system sullage and storm water are also carried separately in closed or open drains upto the point of disposal, where they are allowed to mix up with streams, rivers or sea.

MERITS AND DEMERITS OF CONSERVANCY SYSTEM:

ADVANTAGES:

Initial cost is low, because storm water can pass through open drains.

The quantity of sewage reaching at the treatment plant before disposal is low

The sewer section is small and no deposit of silting because storm water goes in open drains.

DISADVANTAGES:

Possibility of **storm water may mix with sewers causing heavy load** on treatment plant.

In crowded lanes it is **difficult lay two sewers** or construct drains roadside causing great inconvenience to the traffic

Aesthetic appearance of city cannot be increased.

Decomposition of sewage causes insanitary conditions which are dangerous to the public health.

This system is completely depends upon the mercy of sweepers

WATER CARRIAGE SYSTEM

In this system, the waste matters are **mixed up in the large quantity of water** and are taken out from the city through properly designed sewerage systems where they are disposed off after necessary treatment in a satisfactory manner.

The sewage so formed in water carriage system consists of **99.9 percentage of water and 0.1 percentage of solid matters**. All the solid matters remain in suspension in the sewage and do not change the specific gravity of water. So all the hydraulic formulae can be directly used in the design of sewerage system and treatment plants.

MERITS AND DEMERITS OF WATER CARRIAGE SYSTEM

The following are the **MERITS** of water carriage system.

It is **hygienic method** because all the excremental matters are collected and conveyed by water only. There is no nuisance in the streets of town and **risk of epidemics reduced** because of underground sewerage system.

Less space is occupied in crowded lane as only one sewer is laid

Self cleaning velocity can be obtained even at less gradients due to more quantity of sewage.

This **system does not depend on manual labor** at every time except when sewers get choked.

The usual water supply is sufficient and no additional water is required in water carriage system.

Sewer after proper treatment can be used for various purposes.

DEMERITS

1. This system is very costly in initial cost.
2. The maintenance of this system is also costly.
3. During monsoon large volume of sewage is to be treated

TYPES OF SEWERAGE SYSTEM AND THEIR SUITABILITY

The sewerage system are classified as follows:

- (a) **Combined system**
- (b) **Separate system**
- (c) **Partially separate system**

COMBINED SYSTEM

This system is best suited in areas having small rainfall, as self-cleaning velocity will be available in every season. As only one sewer is laid in this system, it is best suited for crowded area

because of traffic problems. The combined system can also be used in area having less sewage, to obtain the self-cleaning velocity.

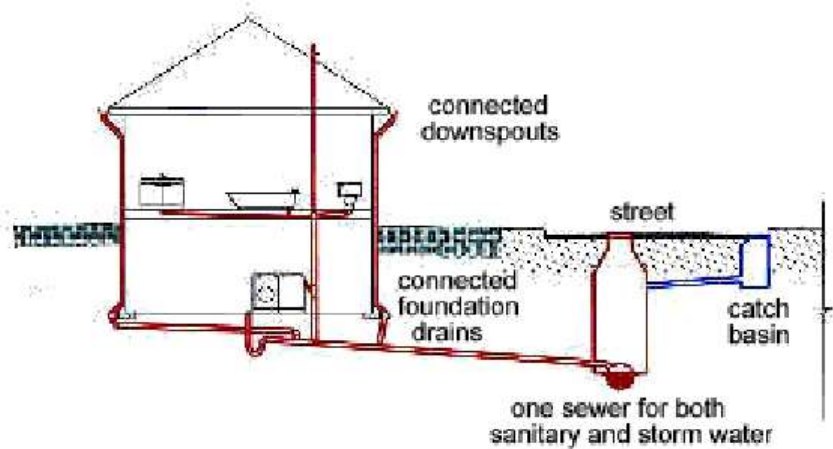

MERITS

The following are the merits of combined system

1. There is no need of flushing because self-cleaning velocity is available at every place due to more quantity of sewage.
2. The sewage can be treated easily and economically because rainwater dilutes the sewage.
3. House plumbing can be done easily only one set of pipes will be required.

DEMERITS

1. The initial cost is high as compared to separate system
2. It is not suitable for areas having rainfall for smaller period of year because resulting in the silting up of the sewers due to self velocity is not available
3. During heavy rainfall, the overflowing of sewers will endanger the public health
4. If whole sewage is to be disposed of by pumping, it is uneconomical

SEPARATE SYSTEM

When domestic and industrial sewage are taken in one set of sewers, where as storm and surface water are taken in another set of sewers, it is called separate system.

MERITS AND DEMERITS SEPARATE SYSTEM

MERITS

The following are the merits of the separate system

1. Since the sewage flows in separate sewer, the quantity to be treated is small which results in economical design of treatment works.
2. Separate system is cheaper than combined system, because only sanitary sewage flows in closed sewer and storm water which is unfoul in nature can be taken through open channel or drains, whereas both types of sewage is to be carried in closed sewer in combined system
3. During disposal if the sewage is to be pumped, the separate system is cheaper
4. There is no fear of steam pollution.

DEMERITS

- Flushing is required at various points because self-cleaning velocity is not available due to less quantity of sewage
- There is always risk that the storm water may enter the sanitary sewage sewer and cause over-flowing of sewer and heavy load in the treatment plant
- Maintenance cost is more because of two sewers
- In busy lanes laying of two sewers is difficult which also causes great inconvenience to the traffic during repairs

PARTIALLY SEPERATE SYSTEM:

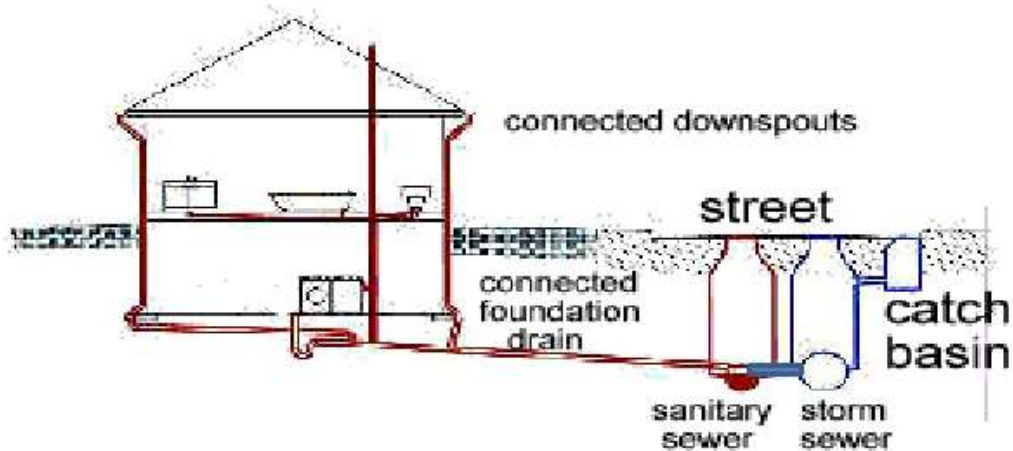

In the separate system, if a portion of storm water is allowed to enter in the sewers carrying sewage and the remaining storm water flows in separate set of sewers, it is called partially separate system

MERITS AND DEMERITS OF PARTIALLY SEPERATE SYSTEM:

MERITS:

1. It is economical and reasonable size sewers are required because as it is an improvement over seperate system.
2. The work of house-plumbing is reduced because the rain water from roof, sullage from bath and kitchen, can be taken in the same pipe carrying the discharge from the water closets. The water from all other places can be taken in seperate sewer or drain.
3. No flushing is required because small portion of storm water is allowed to enter in sanitary sewage.

DEMERITS:

1. Cost of pumping is more than separte system when pumping is required because portion of storm water is mixed.
2. There are possibilities of over-flow.
3. In dry weather, the self cleaning velocity may not develop.

SEPARATE SYSTEMS

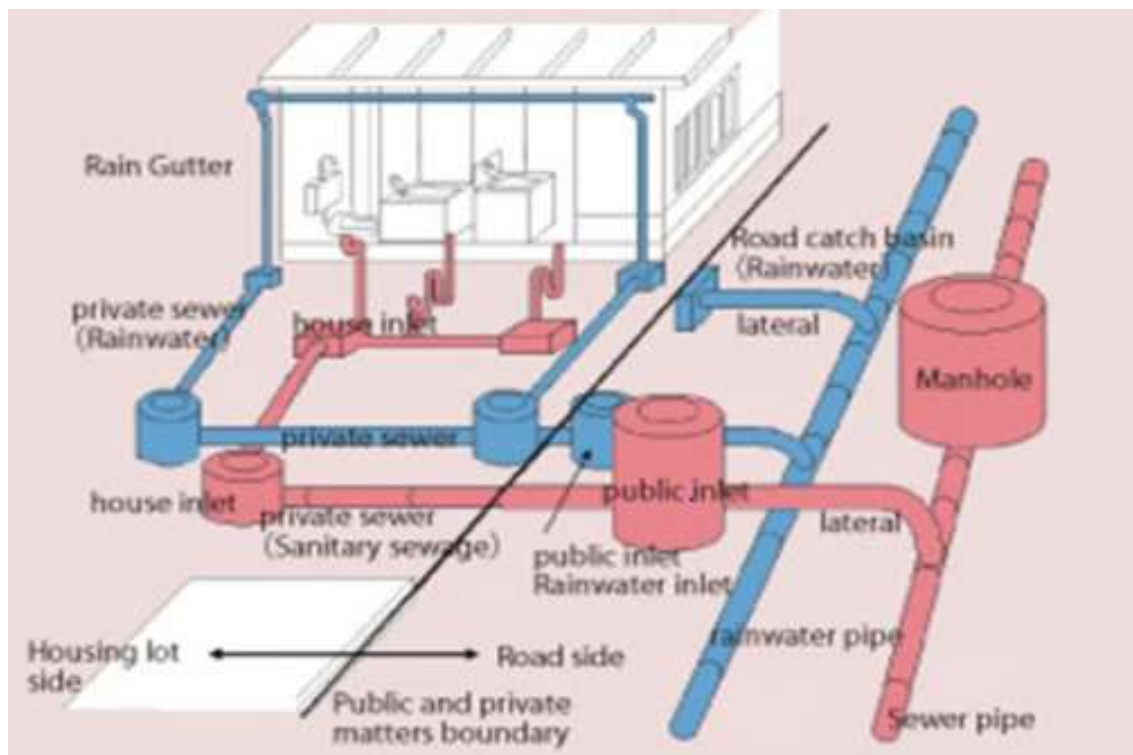

COMBINED SYSTEMS

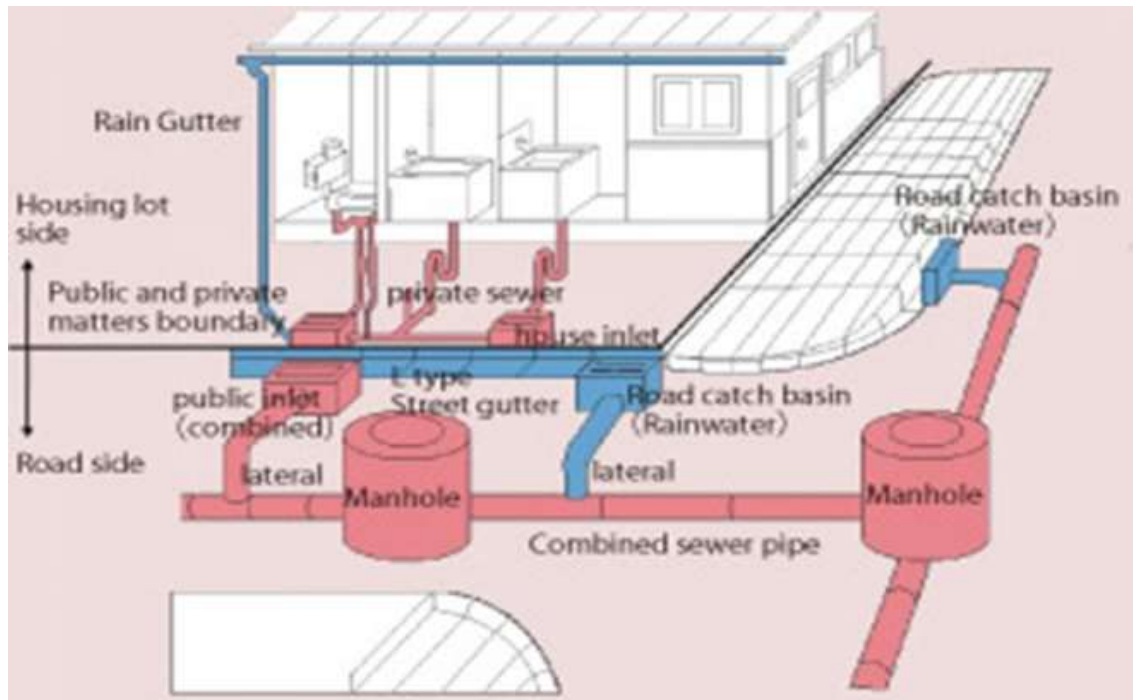

DURING DRY WEATHER

Normal sewage flow is contained within the system and flows to the Wastewater Treatment Plant.



DURING STORMY WEATHER

The combination of stormwater and sewage can exceed normal capacity and overflows into area waterways.



CONSIDERATIONS FOR THE TYPE OF SYSTEM

- ❑ The Separate system requires laying of two set of conduits whereas in combined system only one bigger size conduit is required.
- ❑ Laying of two separate conduits may be difficult in congested streets

- ❑ In combined systems sewers are liable for silting during non monsoon season, hence they are required to be laid at steeper gradients.
- ❑ Large quantity of waste water is required to be treated before discharge in case of combined system. Hence large capacity treatment plant is required.
- ❑ In separate system only sewage is treated before it is discharged into natural water or used for irrigation.
- ❑ No treatment is generally given to the rain water collected before it is discharged in to natural water body
- ❑ In case of separate system pumping is only required for sewage . For storm water is not needed.
- ❑ In combined system large capacity pumping station is required to safely handle the flow that is likely to be generated highest design storm considered
- ❑ Based on site conditions the economy of the system needs to be evaluated and selection is made accordingly.

QUANTITY OF DISCHARGE IN SEWERS

The quantity of discharge in sewers is mainly affected by the following factors.

- ❑ RATE OF WATER SUPPLY
- ❑ POPULATION
- ❑ TYPE OF AREA SERVED AS RESIDENTIAL, INDUSTRIAL OR COMMERCIAL
- ❑ GROUND WATER INFILTRATION

PATTERNS OF COLLECTION – SEWERS

- The network of sewers consists of house sewers discharging the sewage to laterals.
- The lateral discharges the sewage into the branch sewers or sub mains
- Sub-mains discharge it into main sewer or trunk sewer
- The trunk sewer carries sewage to the common point where adequate treatment is given to the sewage and then it is discharged.

FACTORS DEPEND ON PATTERNS OF COLLECTION OF SEWERS

- ❑ Topographical
- ❑ Hydrological

- ❑ Location and methods of treatments adopted for disposal works
- ❑ Types of sewerage system employed
- ❑ Extent of area to be served

TYPES OF PATTERN

- ❑ Perpendicular Pattern
- ❑ Interceptor Pattern
- ❑ Radial Pattern
- ❑ Fan Pattern
- ❑ Zone pattern

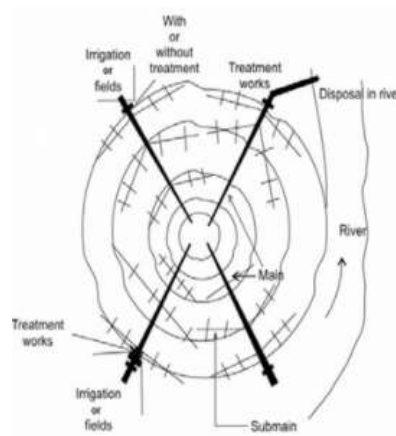
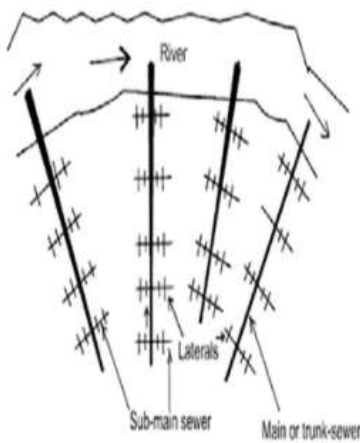
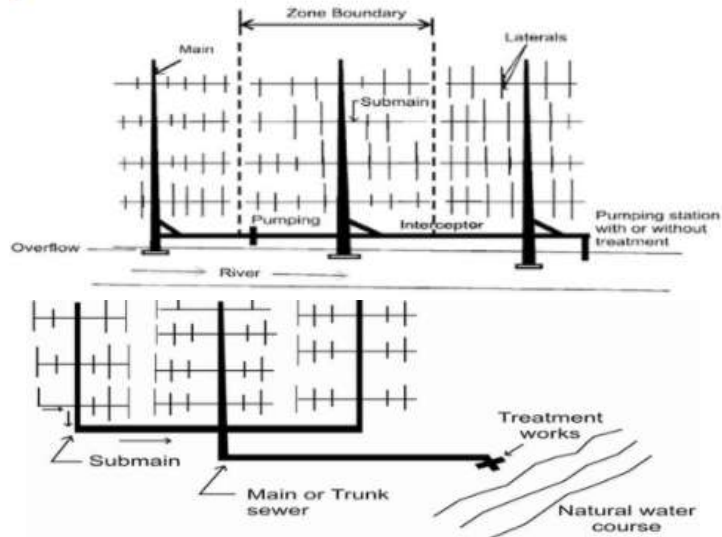

Perpendicular Pattern

- Shortest possible path is maintained for the rains carrying storm water and sewage
- It is suitable for separate system for storm water drains
- This pattern is not suitable for combined system because treatment plant is required to be installed at many places otherwise it will pollute the water body where the sewage is discharged

Interceptor Pattern

- Sewers are intercepted with large size of sewers
- Interceptor carries sewage to a common point where it can be disposed off with or without treatment
- Overflow should be provided to handle very large flow

Radial Pattern

- It is suitable for land disposal
- In this pattern sewers are laid radially outwards from the centre hence this pattern is called as radial pattern
- The drawback in this pattern is more number of disposal works are required

Fan Pattern

- It is suitable for a city situated at one side of the natural water body such as river
- The entire sewage flows to common point where one treatment plant is located
- In this type number of converging main sewers and main sub mains are used forming a fan shape.
- Drawback is large diameter is required near to the treatment plant as entire sewage is collected at a common point
- In addition to it new development of city the load on existing treatment plant increases.

Zone Pattern

- More number of interceptors are provided in this pattern
- This pattern is suitable for sloping area than flat surfaces

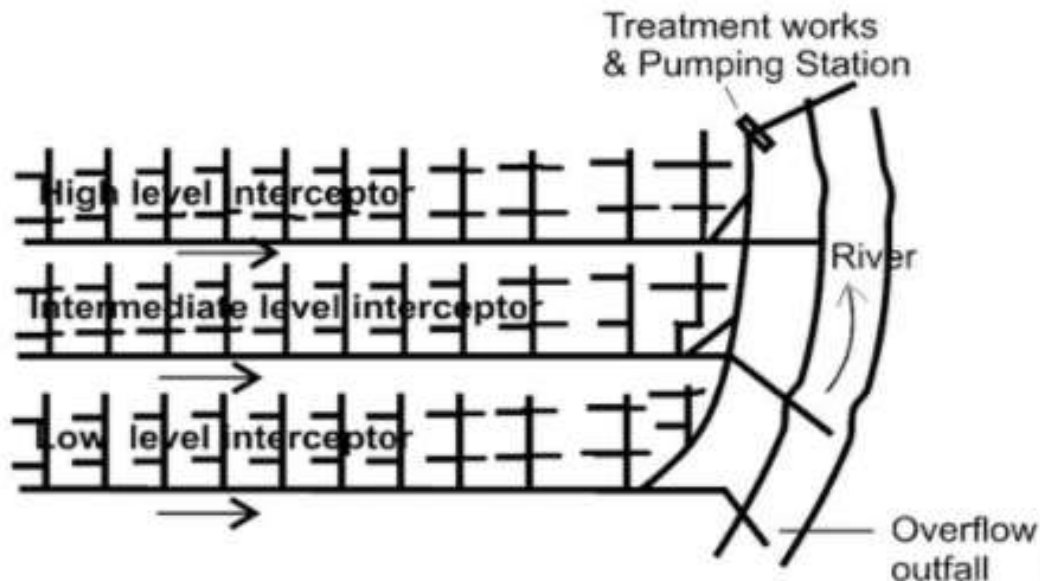

MATERIALS USED

The following are the various materials, which are used for sewers

- Asbestos cement sewers
- Brick sewers
- Cast-Iron sewers
- Cement concrete sewers

- Corrugated iron sewers
- Plastic sewers
- Steel sewers
- Stoneware sewers
- Wood sewers

SHAPES USED –STORM SEWERS

The following are the four shapes, which are commonly adopted in the construction of surface drains

- RECTANGULAR SURFACE DRAINS**
- SEMI-CIRCULAR SURFACE DRAINS**
- U-SHAPED SURFACE DRAINS**
- V-SHAPED SURFACE DRAINS**



OUTLINE OF SEWAGE SEWERS

Sewerage are **closed conducts** are called sewers and are laid under ground for **conveying foul discharges from water-closets of public and domestic buildings, chemical mixed water from industries** without creating any nuisance outside the town.

Sewers should have such cross-section that **self-cleaning velocity** should be developed even during dry weather flow. **No deposit should settle down** in the bed of sewers under any circumstances. These should **be laid in the town at such a slope that water in case of flood in river** at the outlet should not come out from manholes and **cause insanitary conditions**

DESIGN CONSIDERATION – SEWAGE SEWERS

Following design period can be considered for different components of sewerage scheme.

- Laterals less than 15 cm diameter : Full development
- Trunk or main sewers : 40 to 50 years
- Treatment Units : 15 to 20 years
- Pumping plant : 5 to 10 years

DESIGN DISCHARGE OF SANITARY SEWAGE

- The total quantity of sewage generated per day is estimated as product of forecasted population at the end of design period considering per capita sewage generation and appropriate peak factor.

- ❑ The per capita sewage generation can be considered as 75 to 80% of the per capita water supplied per day.
- ❑ The increase in population also result in increase in per capita water demand and hence, per capita production of sewage
- ❑ This increase in water demand occurs due to increase in living standards, betterment in economical condition, changes in habit of people, and enhanced demand for public utilities

FACTORS CONSIDERED FOR SELECTING MATERIAL - SEWER

Following factors should be considered before selecting material for manufacturing sewer pipes

- ❑ **RESISTANCE TO CORROSION**
- ❑ **RESISTANCE TO ABRASION**
- ❑ **STRENGTH AND DURABILITY**
- ❑ **WEIGHT OF THE MATERIAL**
- ❑ **IMPERVIOUSNESS**
- ❑ **ECONOMY AND COST**
- ❑ **HYDRAULICALLY EFFICIENT**

RESISTANCE TO CORROSION

Sewer carries wastewater that releases gases such as H₂S. This gas in contact with moisture can be converted into sulfuric acid. The formation of acids can lead to the corrosion of sewer pipe . Hence, selection of corrosion resistance material is must for long life of pipe

RESISTANCE TO ABRASION

Sewage contain considerable amount of suspended solids, part of which are inorganic solids such as sand or grit. These particles moving at high velocity can cause wear and tear of sewer pipe internally. This abrasion can reduce thickness of pipe and reduces hydraulic efficiency of the sewer by making the interior surface rough

STRENGTH AND DURABILITY

The sewer pipe should have sufficient strength to withstand all the forces Sewers are subjected to considerable external loads of backfill material and traffic load, if any . They are not subjected to internal pressure of water. To withstand external load safely without failure, sufficient wall thickness of pipe or reinforcement is essential. In addition, the material selected should be durable and should have sufficient resistance against natural weathering action to provide longer life to the pipe

WEIGHT OF THE MATERIAL

The material selected for sewer should have less specific weight, which will make pipe light in weight. The lightweight pipes are easy for handling and transport .

IMPERVIOUSNESS

To eliminate chances of sewage seepage from sewer to surrounding, the material selected for pipe should be impervious

ECONOMY AND COST

HYDRAULICALLY EFFICIENT

The sewer shall have smooth interior surface to have less frictional coefficient

SHAPES USED –SEWERAGE SEWERS

- ❑ SEWERS CIRCULAR
- ❑ SEWERS NON CIRCULAR

Generally the sewers of circular shape are adopted because of following facts

- ❖ **Circular shape** affords **least perimeter** and hence construction cost is minimum for the same area of other shape
- ❖ **Deposition of organic matter** are reduced to minimum **because of no corners**
- ❖ They are **easy to manufacture or construct and handle**
- ❖ Because of circular shape, these are subjected to hoop compression hence the Concrete required is minimum and **no reinforcement is required** They possess excellent hydraulic properties because they provide the maximum hydraulic mean depth when running full or half full.

SHAPES USED –SEWERAGE SEWERS

- ❑ BASKET HANDLE SECTION
- ❑ CATENARY-SHAPED SECTION
- ❑ EGG-SHAPED OR OVOID SECTION
- ❑ HORSE-SHOE SECTION
- ❑ PARABOLIC SECTION
- ❑ RECTANGULAR OR BOX TYPE SECTION
- ❑ SEMI-CIRCULAR
- ❑ SEMI-ELLIPTICAL SECTION
- ❑ U-SHAPED SECTION

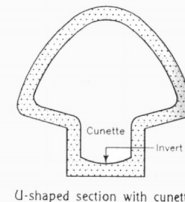
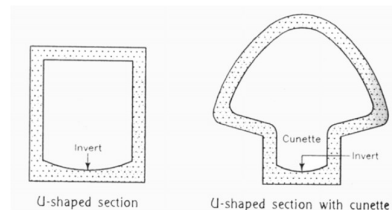
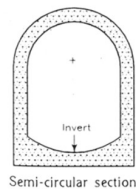
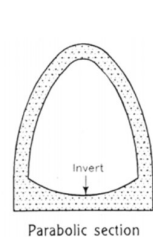
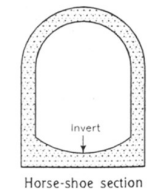
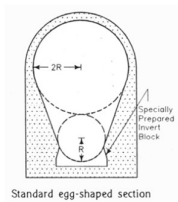
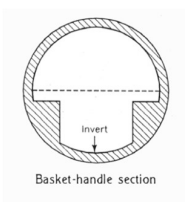
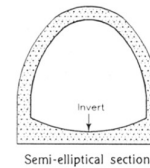

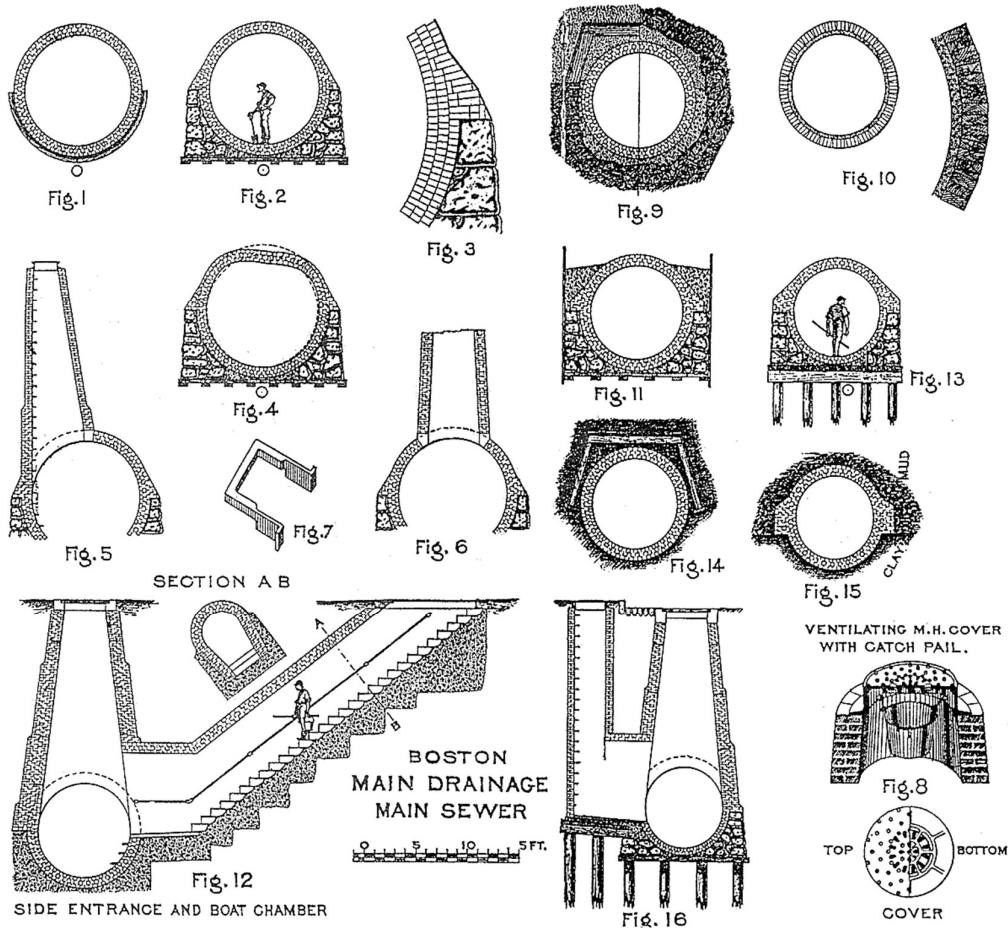

LAYING OF SEWERS

The construction of sewer consists of the following works

- Marking center lines of sewers
- Excavation of trenches
- Checking the gradient
- Preparation of bedding
- Laying of sewers
- Jointing
- Back filling

Marking center lines of sewers

The center line of a sewers are marked on the streets and roads from the plans starting from the lowest point or outfall of the main proceeding upwards. The setting out of work is done by means of chain and theodolite or compass. For checking the center line during the construction generally wooden pegs or steel spikes are driven at 10 meters intervals on a line parallel to the center where while laying sewers, they will not disturb them. For checking the levels of sewer pipes and their alignment temporary benchmarks are established at 200-400 metres intervals. The reduced level (R.L) of these

benchmarks should be calculated with respect to G.T.S benchmarks. On the center line position of sewer appurtenances are also marked

Excavation of trenches

After marking the layout of the sewer lines on the ground, the first step is the removal of pavement, which starts from the lower end of the sewers and proceeds upwards. Pickaxes, spade or pneumatic drills can be used in case of removing concrete pavements. After removing pavements, the excavation of trenches is done manually or machinery.

The width of trench depends upon the dia of sewer and depth of sewer line below the ground level. The width of sewer line is 15cm more than external diameter of sewer for easiness in lowering and adjusting the sewer pipe. The minimum trench width of 60 to 100cm is necessary for conveniently laying and jointing of even very small size sewers.

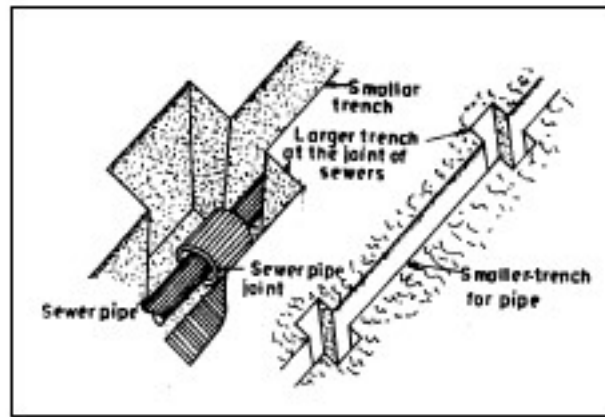
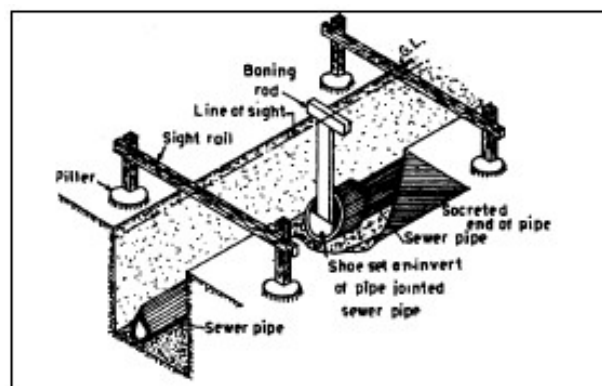

Fig 3.9 Excavation of Trenches

PREPARATION OF BEDDING

Trenches are excavated with proper grade so that sewage may flow in sewer due to gravitational flow only. The centre line of sewers and their grades are transferred from the ground by means of sight rail and boning rod



When a sewer has to be laid in a soil underground strata or in a reclaimed land, the trench shall be excavated deeper than what is ordinarily required trench bottom or rock. In the case of very bad soil the trench bottom shall be filled in with cement concrete of appropriate grade. In areas subject to subsidence the pipe sewer shall be laid on a

timber platform or concrete cradle supported on piles. In the case of cast-in-site sewers and R.C.C section with reinforcement, bearing capacity is encountered and soil stabilization shall be done either by rubber, concrete or wooden crib.

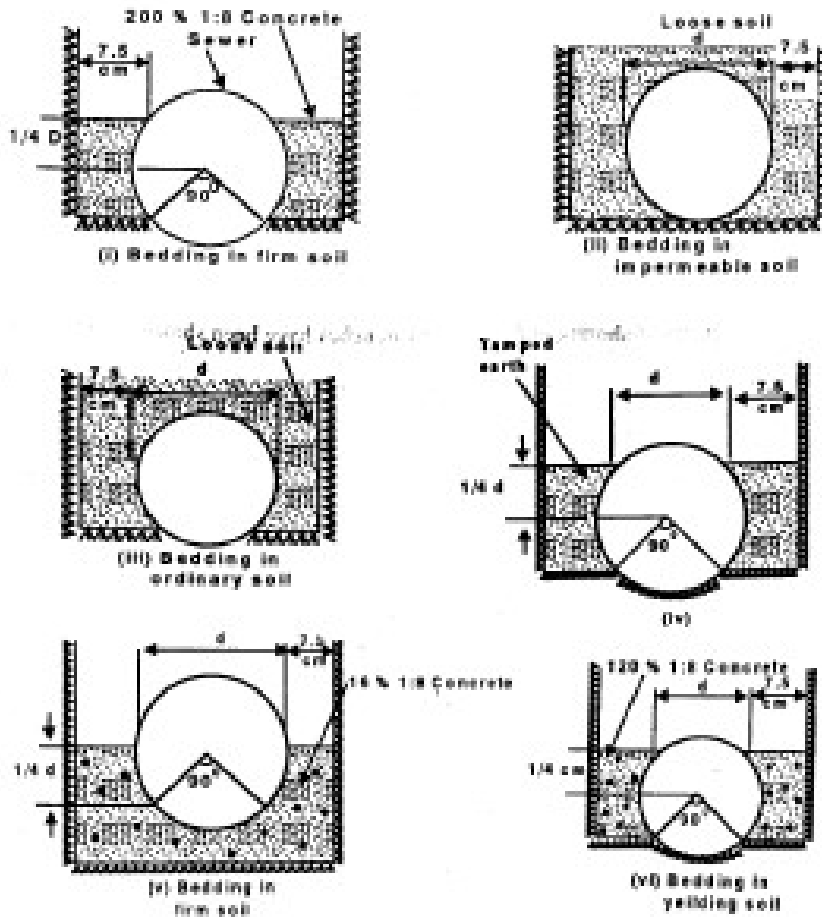

LAYING

Smaller size pipes can be laid by the pipe-layers directly by hand only. But heavier and larger size pipes are lowered in the trenches by passing ropes around them and supporting through hock . It is the common practice to lay the pipes with their socket end upgrade for easiness in joining. After lowering the pipes these are brought near and spigot end of one pipe is placed in the socketed end of the other after properly placing and arranging the pipes they are suitably joined. The joints are carefully cured for sufficient time.

TESTING OF SEWERS

WATER TEST

Each section of sewer shall be tested for water tightness preferably between manholes.

In case of concrete and stoneware pipes with cement mortar joints, pipes shall be tested three days after the cement mortar joints have been made.

The sewers are tested by plugging the ends with a provision for an air outlet pipe with stop-cock in the upper end.

The water is filled through a funnel connected at the lower end provided with a plug. After the air has been expelled through the air outlet, the stop-cock is closed and water level in the funnel is raised to 2.5 m above the invert at the upper end.

Water level in the funnel is noted after 30 minutes and the quantity of water required to restore the original water level in the funnel is determined.

Leakage in 30 minutes determined by measuring the replenished water in the funnel should not exceed 15ml for smaller and 60 ml for larger diameter pipes for 100m length.

AIR TEST

Air testing becomes necessary particularly in large diameter pipes when the required quantity of water is not available for testing.

As per the ASTM C28-80, vitrified clay pipes testing is specified as applying air pressure to 2.8 m water column and held for 2 to 5 minutes when all plugs are checked and the exact point of leakage can be detected by applying soap solution to all the joints in the line and looking for air bubbles. Thereafter, the air supply is disconnected and the time taken to drop from 2.5 m to 1.7 m water column for every 30 m

In case drop is more than 25mm the leaking joints shall be traced and suitably treated to ensure water-tightness. The exact position of leak can be detected by applying soap solution to all the joints in the line and looking for air bubbles.

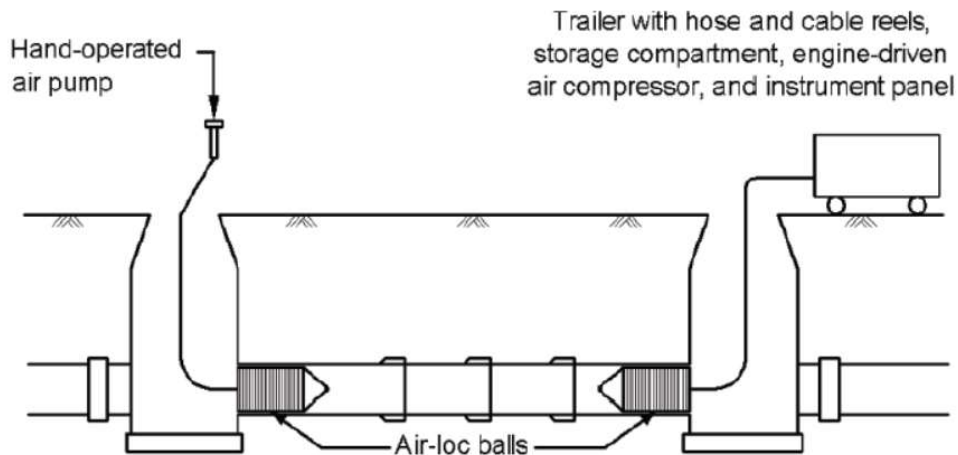

Figure 3.52 Typical arrangement for low pressure air testing of sewer pipeline

STRAIGHT ALIGNMENT TEST

(i) Tests for Straightness and Obstruction:

As soon as a section of sewer is laid it is tested for straightness and obstruction.

These tests are carried out in the following two ways:

At the high end of the sewer a smooth ball of diameter 13 mm less than the pipe bore is inserted. If there is no obstruction such as yarn or mortar projecting through the joints, the ball will roll down the invert of the pipe and emerge at the lower end.

A mirror is placed at one end of the sewer line and a lamp is placed at the other end. If the sewer line is straight, the full circle of light will be observed. If the sewer line is not straight, this would be apparent. The mirror will also indicate any obstruction in the sewer line

SEWER APPURTENANCES

The structures, which are constructed at suitable intervals along the sewerage system to help its efficient operation and maintenance, are called as sewer appurtenances.

These include:

- Manholes
 - Working Chamber
 - Access Shaft
- Drop manholes
- Lamp holes
- Clean-outs
- Street inlets called Gullies
- Catch basins
- Flushing Tanks
- Grease & Oil traps
- Inverted Siphons
- Storm Regulators

MANHOLES

LOCATION

Manholes are provided at every change of alignment, gradient or diameter of the sewer.

FUNCTION

Manholes are provided for inspection, cleaning, repairs and maintenance of the sewer.

CONSTRUCTION

A Manhole consists of

- Working chamber.**
- An access shaft and**
- A strong cover on the top flush with the road level.**

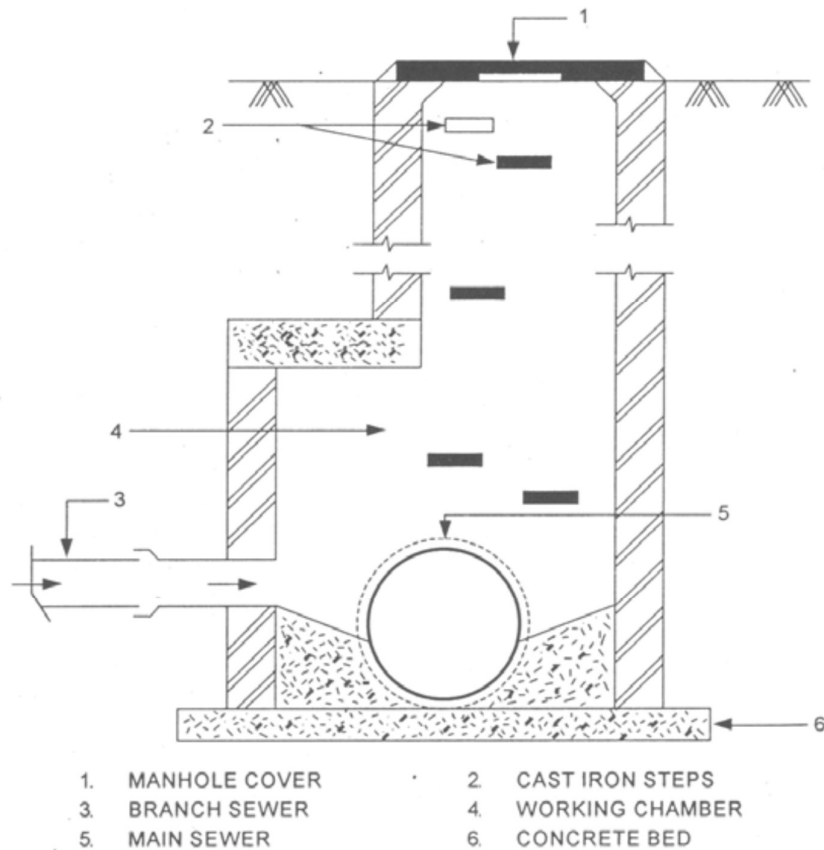

WORKING CHAMBER

The working chamber has such a size, so that necessary examination and cleaning can be done easily. The minimum internal size of the chamber are as follows

- (i) For depth of 0.8m or less _____ 0.75m x 0.75m
- (ii) For depth between 0.8m and 2.1m _____ 1.2m x 0.9m
- (iii) For depth more than 2.1m _____ 1.2m x 0.9m

ACCESS SHAFT

The access shaft provides an access to the working chamber. The shaft is formed, by corbelling the working chamber So that the cover frame can be fitted in the opening, the minimum internal dimensions of the access shaft are 0.5 x 0.5m

COVER

At the top of manhole, the manhole cover of cast iron or R.C.C is provided to cover the opening depending upon the type of traffic on the road.

The manhole covers are provided flush with the road level.

The bottom of the manhole is usually made of concrete slightly sloped at the top towards the open channels, which are in continuation of the sewer line

The channels are sometimes lined with half-round sewer pipe section. The top surface of the concrete is called benching and the man stands on its top during cleaning and inspection of the sewer lines over the cement concrete walls not less than 20cm thickness are constructed

Circular shape is structurally more stable and stronger though it is difficult in construction. The maximum distance between two manholes should be 30m and the distance between the manhole and gully chambers should not exceed 6m.

DROP MANHOLE

If the difference in level between the branch sewer and main sewer is within 60cm and there is sufficient roof within the working chamber, the connecting pipe may be directly brought through the manhole wall by providing a ramp in benching.

Such manholes which drop the level of invert of the incoming sewer, by providing a vertical shaft are called drop manholes

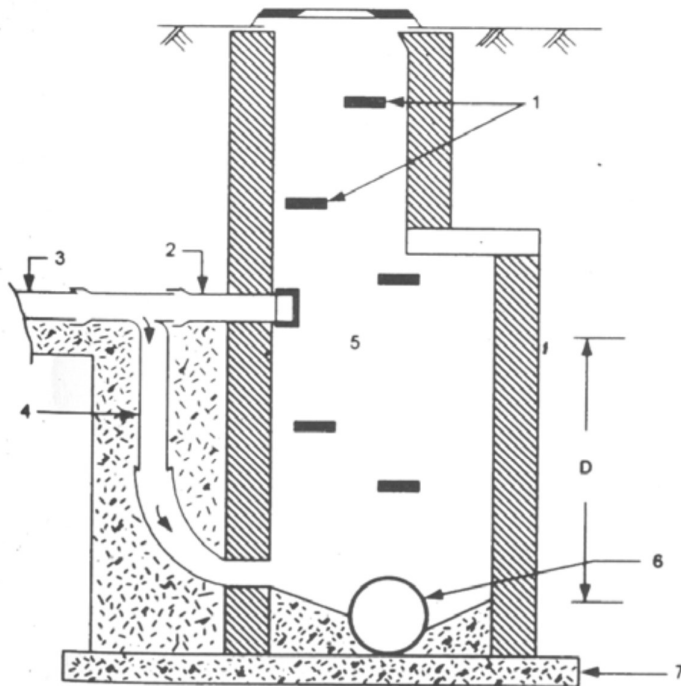

- | | |
|------------------------|-------------------|
| 1. CAST IRON STEPS | 2. INSPECTION ARM |
| 3. BRANCH SEWER | 4. VERTICAL PIPE |
| 5. WORKING CHAMBER | 6. MAIN SEWER |
| 7. CONCRETE FOUNDATION | |

The main purpose being to avoid the splashing of sewage on the man working and on the masonry work.

The branch sewer line is connected to the manhole in such a way that it can be cleaned and rodded when necessary. For inspection of the incoming sewage and cleaning of vertical shaft, the vertical shaft is taken upto the ground level

STREET INLETS

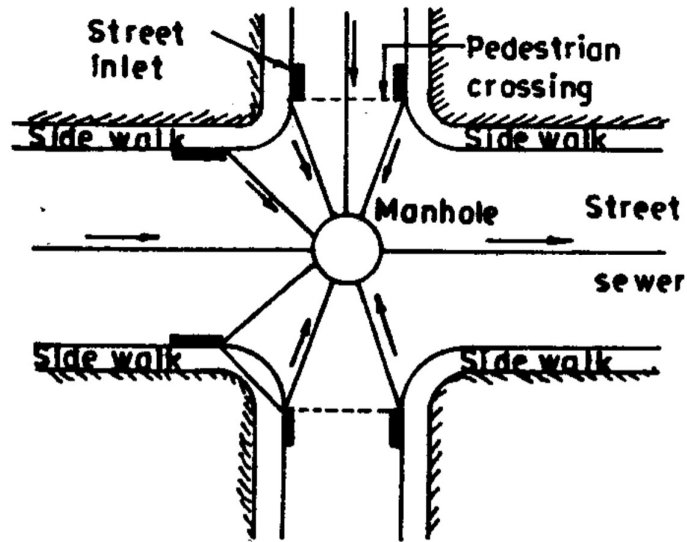

Street inlets or gullies are the openings in the street or gutter to collect the storm water and surface wash flowing along the street and convey it to storm or combined sewer by means of stoneware pipes of 25 to 30cm diameter.

the most useful location of street inlet at the street junction in such way that the storm water may not flow across any of the streets or flood the cross walks causing interference with the traffic street inlets are of **three types**

- ❑ CURB INLET
- ❑ GUTTER INLET
- ❑ COMBINED GUTTER AND CURB INLET

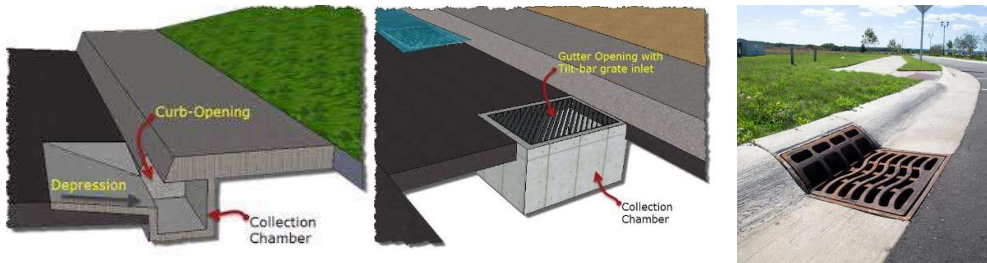

CURB INLET

In which an opening is provided in the road curb for the entrance of storm water. The gutter opening bars are provided to prevent the passage of dry-leaves, papers etc in the sewer line

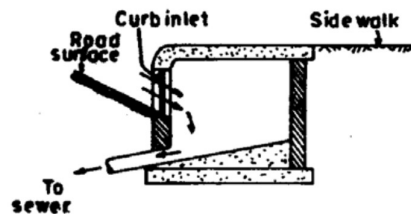

GUTTER INLET

These are placed directly below the road gutter and storm water directly enters them from the top. Such inlets catch very large volume of water and are most suitable in roads having steep slopes. These inlets are provided with cast Iron gratings at their top to prevent floating matters entering the sewer. The top grating should be sufficiently strong to bear the traffic loads. The main difficulty with such inlets is that of the heavy cost and these are mostly stolen and the pit remain uncovered

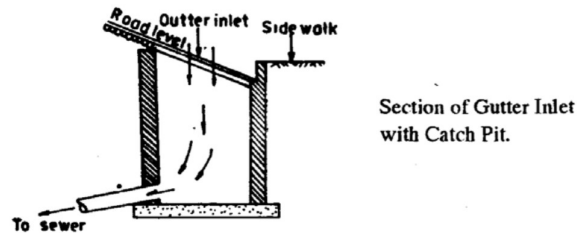

COMBINED GUTTER AND CURB INLET

These inlets in which the storm water enters from both the gutter and curb

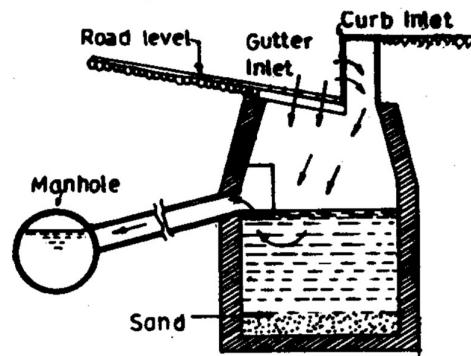

CATCH BASINS

These are small masonry chambers (75 to 90cm in diameter and 75 to 90cm deep) which are constructed below the street inlet to prevent the flow of grit, sand or debris in the sewer lines. The outlet pipe of catch basin is fixed about 60cm.

The outlet pipe is provided with a trap to prevent the escape of odours from the sewer to the catch basins. Catch basins are provided in the following sections.

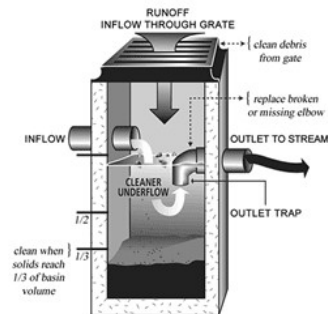

Catch basins collect the solids from the storm water. These solids are to be removed at frequent intervals for the proper functioning of the catch basin otherwise they will block the passage of storm water in the sewers resulting in the flooding of the streets creating nuisance.

FLUSHING TANKS

These are masonry or concrete chambers to flush the sewers when the sewers gradients are flat and velocity of sewage is very low. These are usually provided at the beginning point of the sewers and may be either are automatic or worked by hand.

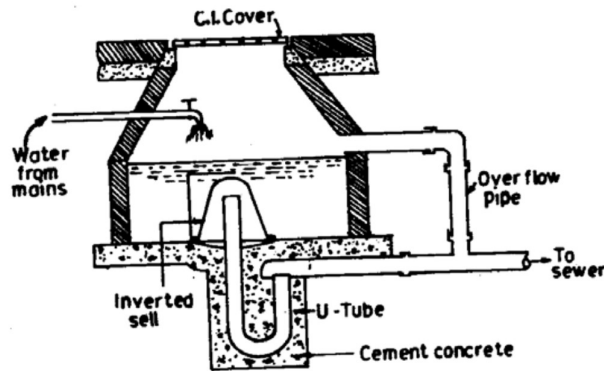

In automatic flushing tank, the water is automatically released from the tank at required intervals, which can be adjusted by supply tap and flushes the sewer

The cleaning operation of a small sewer is generally done by flushing tanks. The flushing tank is a device that stores water temporarily and throws it into the sewer for the purpose of flushing and cleaning the sewer.

Location of Flushing Tank

It is installed at places where there are chances of blockage of [sewer pipes](#). In case of sewer laid on flat topography not producing self-cleaning velocities or near the dead end points of the sewers, flushing tanks are installed.

The Function of Flushing Tank

It helps in flushing and cleaning of sewers. It is also used to store sewage temporarily at some places.

Construction of Flushing Tank

The flushing tanks are of two types:

- a) **Hand operated flushing tank.**
- b) **Automatic flushing tank.**

In a hand-operated flushing tank, the flushing and cleaning operation is carried out at suitable intervals by manual labour. It is carried out by operating the sluice valve fitted at the outlet end and the inlet end of the manhole suitably.

In automatic flushing tank, the flushing and cleaning operation is carried out automatically at regular intervals. It consists of a U-tube encased in a compartment. An overflow pipe is also provided to drain away excess water. This tank functions automatically by [siphon](#) action.

Flushing Tanks

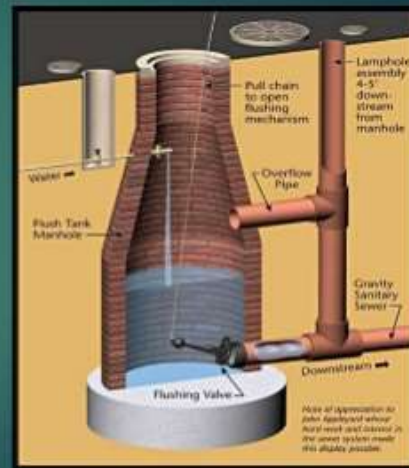
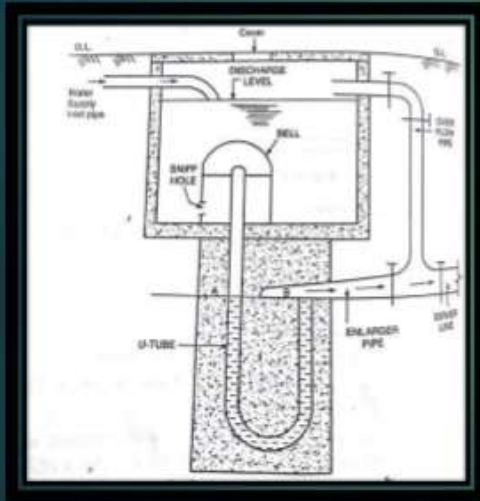

REGULATORS

The structures constructed to divert part of sewage in the case of combined sewers are known as the storm water regulators

The main objective of providing a storm water regulator is to divert the excess storm water to the natural stream or river. The excess sewage will be mainly composed of storm water and it will therefore be not foul in nature and hence decrease in load on the treatment units or pumping stations.

TYPES

- LEAPING WEIR
- OVERFLOW WEIR
- SYPHON SPILLWAY
- INVERTED SIPHON

LEAPING WEIR

Leaping weir is used to indicate the gap or opening in the invert of a combined sewer. The intercepting weir runs at right angles to the combined sewer. If the discharge exceeds certain limit, the excess sewage leaps or jumps across the weir and it is carried to the natural stream or river

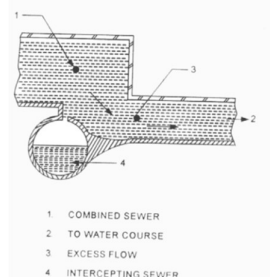

OVERFLOW WEIR

The excess sewage is allowed to overflow in the channel made in the manhole and conveyed to the storm water sewer or channel. In order to prevent the escape of floating matter from the combined sewer channel, adjustable plates are provided. In another arrangement, the openings at suitable height above invert are provided along the length of combined sewer as shown.

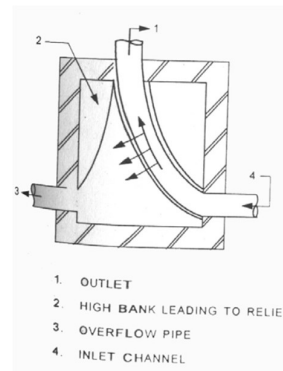

SYPHON SPILLWAY

The arrangement of diverting excess sewage from the combined sewer by the syphonic action is most effective because it operates automatically and requires least maintenance. However it is likely to be clogged due to narrow passage

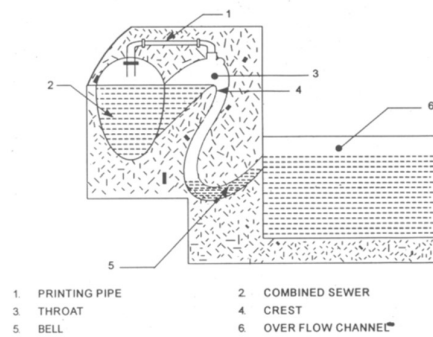

INVERTED SIPHON

Inverted siphon is a sewer section which is constructed lower than the adjacent sewer section and which runs full under gravity with pressure greater than atmosphere

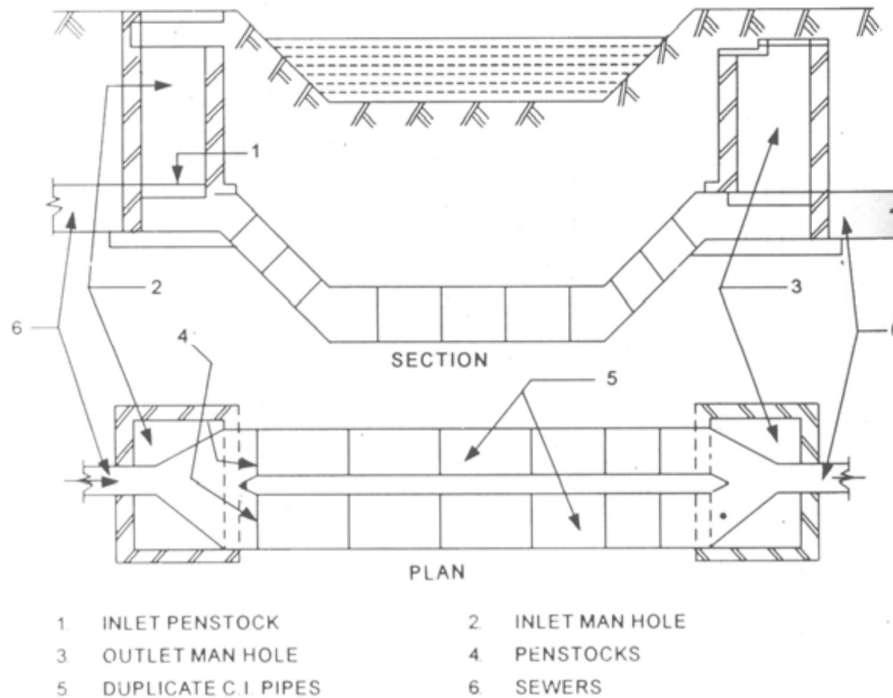

PURPOSE:

The main purpose of inverted siphon is to carry the sewer line below obstruction

Siphon is so designed that a self-cleaning velocity of about 90cm/sec during achieved the period of minimum discharge.

For this purpose, the siphon is usually made of three pipe sections-one for carrying minimum discharge, the other for maximum discharge and the third for combined flow in mansoons. The inlet chamber contains three channels, one for each pipe section.

When channel no. 1 overflows, the sewage enters in channel no. 2 and pipe no. 2 comes into commission. Similarly, when channel no. 2 also overflows the sewage enters channel no. 3 and pipe no. 3 comes into commission

The inlet chamber should be provided with screens to remove silt, grit etc from sewage before enters the siphon